

Kartlegging av eksponering.
Reaktive og ultrafine partikler i
arbeidsmiljøet
Sandnes 2019-06-12

Marianne Dalene; Associate Professor., CEO
Gunnar Skarping, Professor

- Effects
- Climate chamber
- Generation
- Monitoring
 - Size selective sampling & analysis
 - Direct reading
- Technical improvements
- Protective equipment
- Regulation

Sampling of respirable isocyanate particles

- Particle size matters

The definition of the size fractions for inhalable, thoracic and respirable particles was established by the International Organization for Standardization (ISO), the European Committee for Standardization (CEN) and the American Conference of Industrial Hygienists (ACGIH).

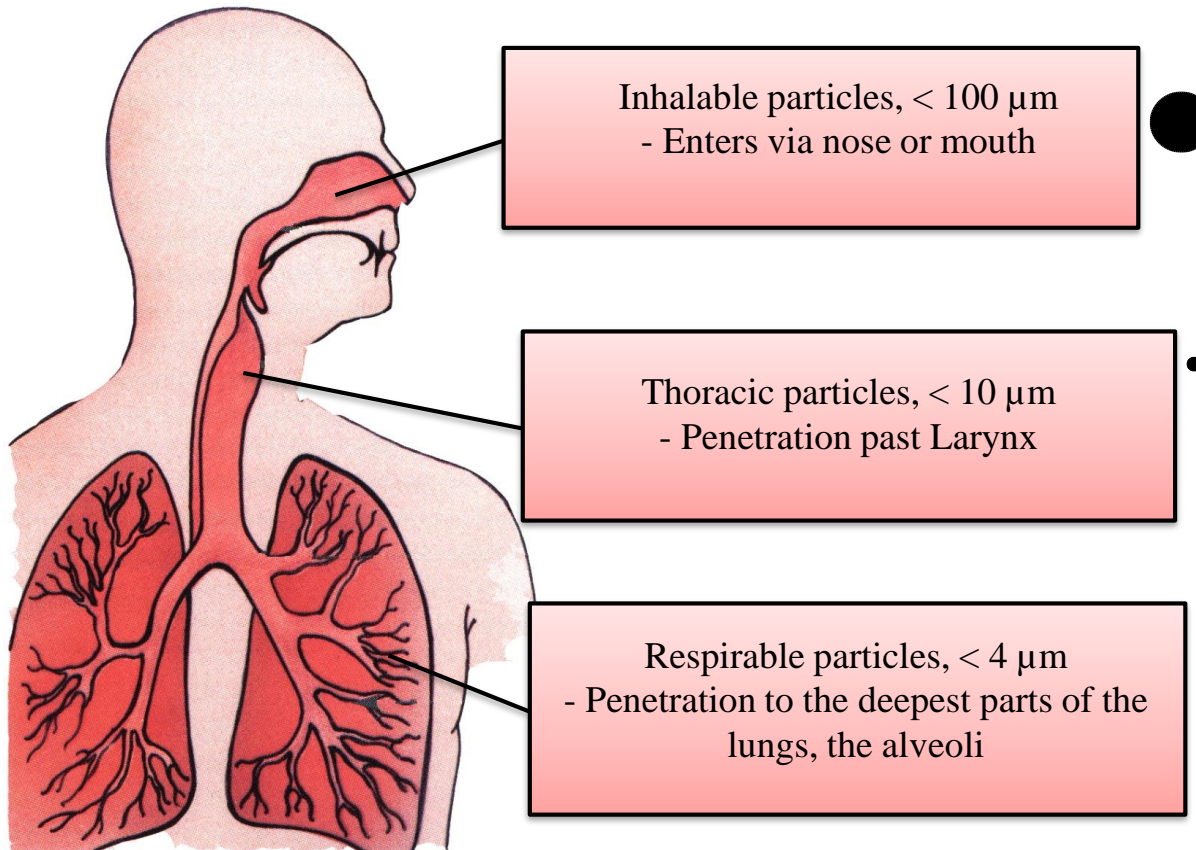

Examples of activities/industries where isocyanates are used and/or generated



Activity/industry	”Cold” handling	”Hot” handling
Automotive industry, ships, aircraft & trains	Painting, filling, sealing, windscreen assembly, bonding, manufacturing of composites, roof-liner pressing, acoustic panel processing, truck bed lining	Cutting, welding, grinding, windscreen removal, removal of underseal
Building	Sealing, bonding, painting, caulking, floor and wall coverings, insulation and roofing	Handling of mineral wool, mat welding, copper pipe welding, paint removal, pipe insulation
Clothing & Leisure industry	Manufacture of PUR-textile, shoes and sports grounds & equipment	Flame lamination
Electrical & electronics	Packaging, gluing, casting	Soldering circuit boards, connecting optical fibres and varnished wires, cable insulation, heating Bakelite
Paint industry	Manufacturing, automotive & industrial painting	Removal of paints & varnishes with heat
Foundry	Manufacturing of cold-box cores	Manufacturing with hot-box technique, casting cores and shell sand
Graphic trades	Manufacturing of printing inks, lamination	Curing, lamination
Foodstuffs	Food packaging	Repair of conveyors, heat sealing of packaging materials
Plastics industry	Manufacture of foam, automotive fittings	Hot wire cutting
Tunnelling and mining	Sealing, rock consolidation	Self-ignition may occur
Wood and furniture	Manufacture of composite wood panels, use of adhesives, varnishing, upholstery padding, painting	Pressing, cutting and routing, removal of paints & varnishes with hot air gun
Engineering	Gluing, manufacture of elastomers, painting, insulation, fixatives	Repairs and removal of polyurethane materials with heat
White goods industry	Manufacture of refrigerators & freezers (PUR insulation), painting	Mineral wool insulation – QA checks, repairs
Medical care	Bandaging, casting, filling, equipment	
Fire extinguishing		Mineral wool, polyurethane in furniture and interior fittings
Offshore installations	?	?

Source strength

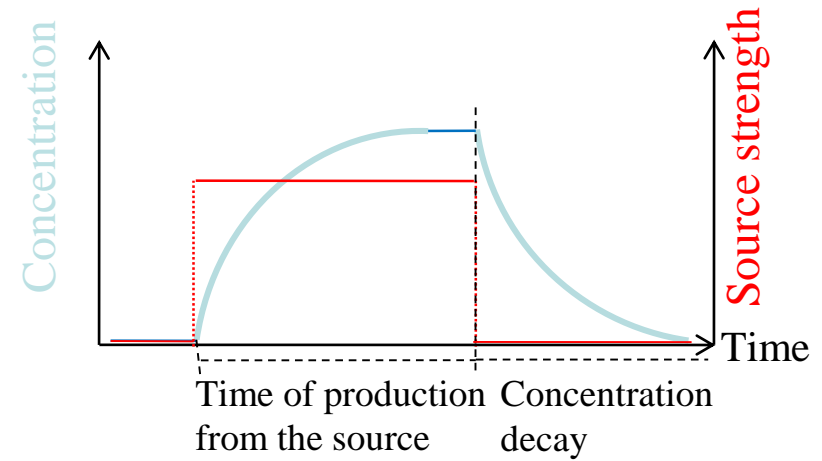

A graph showing how the concentration varies with time during an operation that produces an airborne contaminant inside a well mixed ventilated room.

Climate chamber

Temperature range: -11 °C - +35 °C

Humidity range: 0 %RH - 99 %RH (0-60 %RH <0°C)

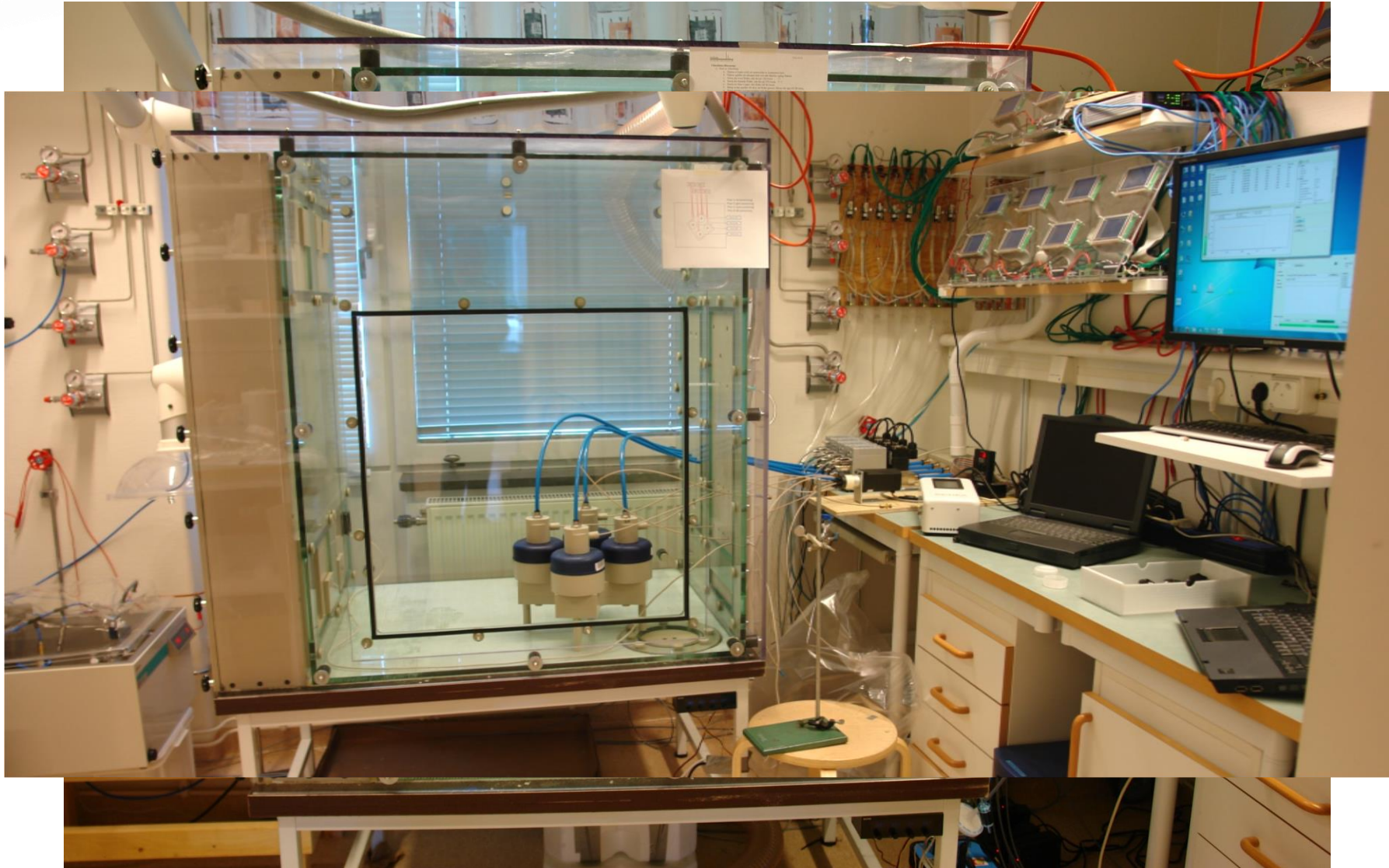

Generation of ICA and MIC

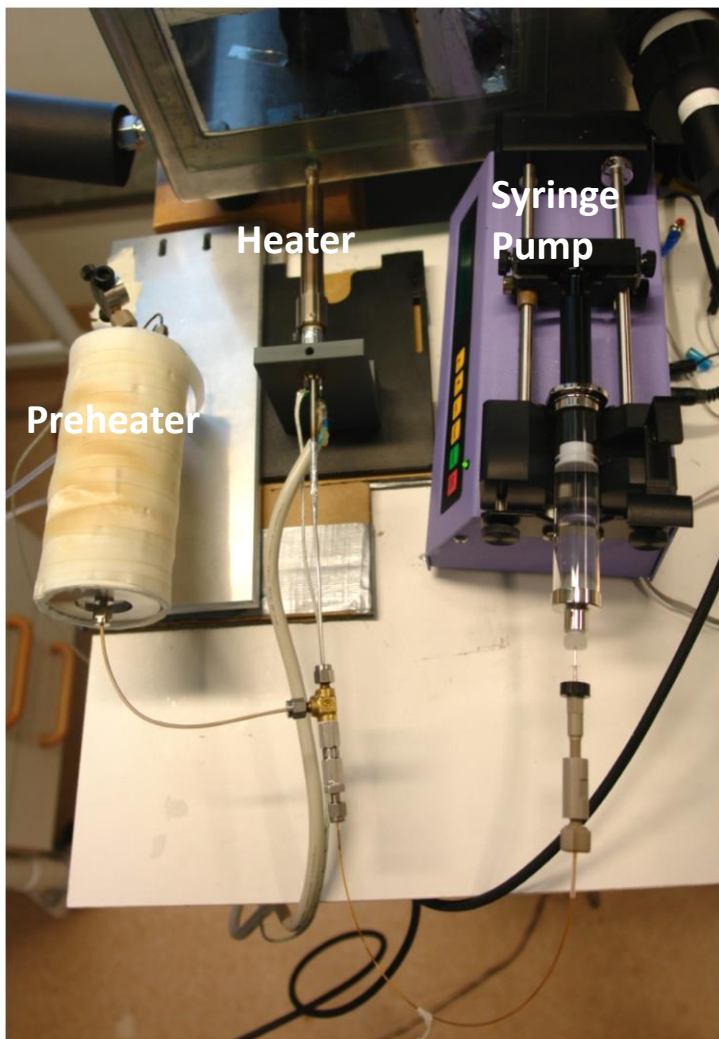

- The generations apparatus has been developed by IFKAN.
- Generation of ICA and MIC by thermal degradation of urea and dimethyl urea.
- A water solution of urea and dimethyl urea is introduced to the carrier gas stream with a syringe pump and brought to heater.

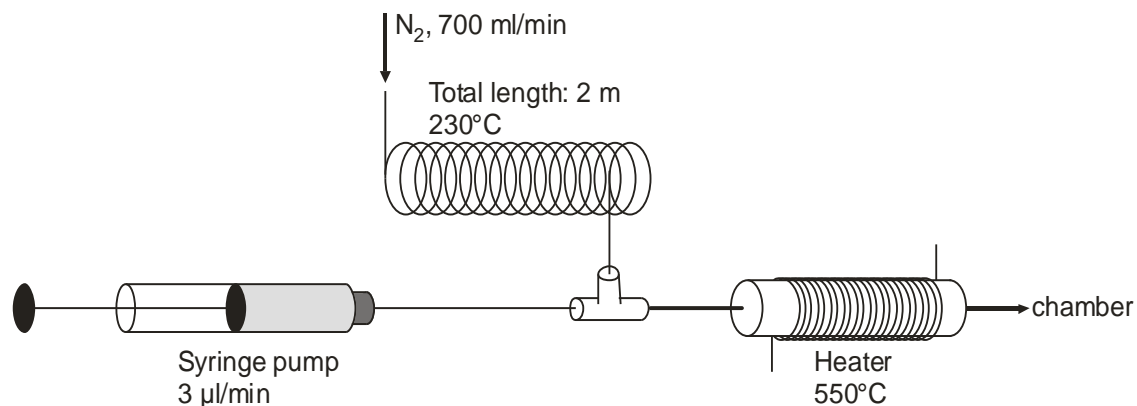

Generation of ICA and MIC



- Generation of ICA and MIC by thermal degradation of urea and dimethyl urea.

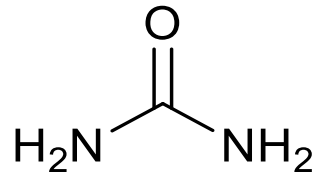

Urea



+



ICA

Ammonia

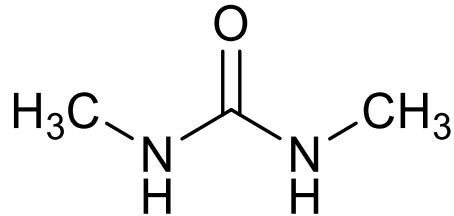

Dimethyl urea

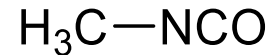

+

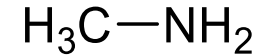

Methyl isocyanate

Methyl amine

Thermal degradation of phenol-formaldehyde-urea resins, bakelite and mineral wool

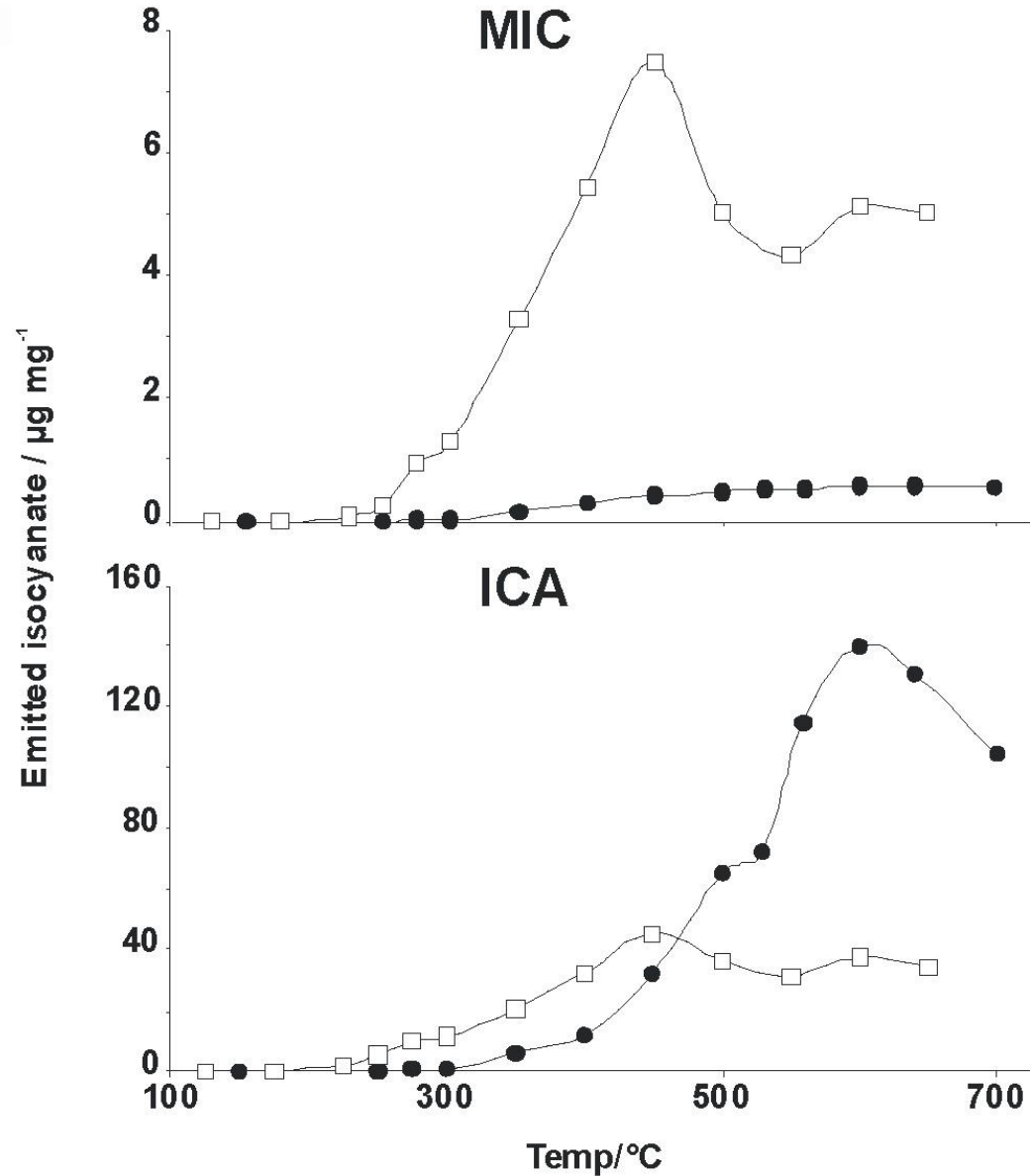

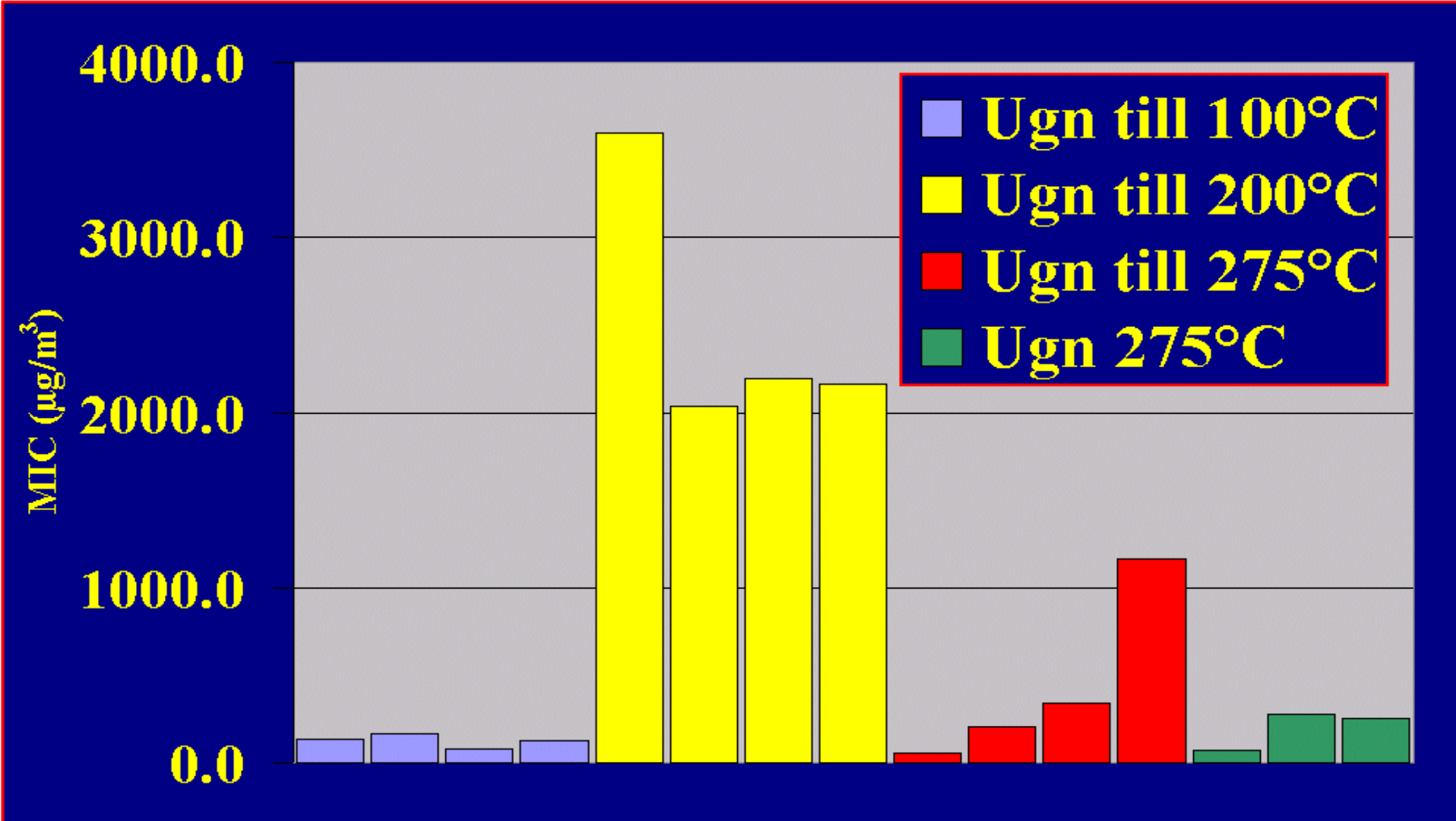

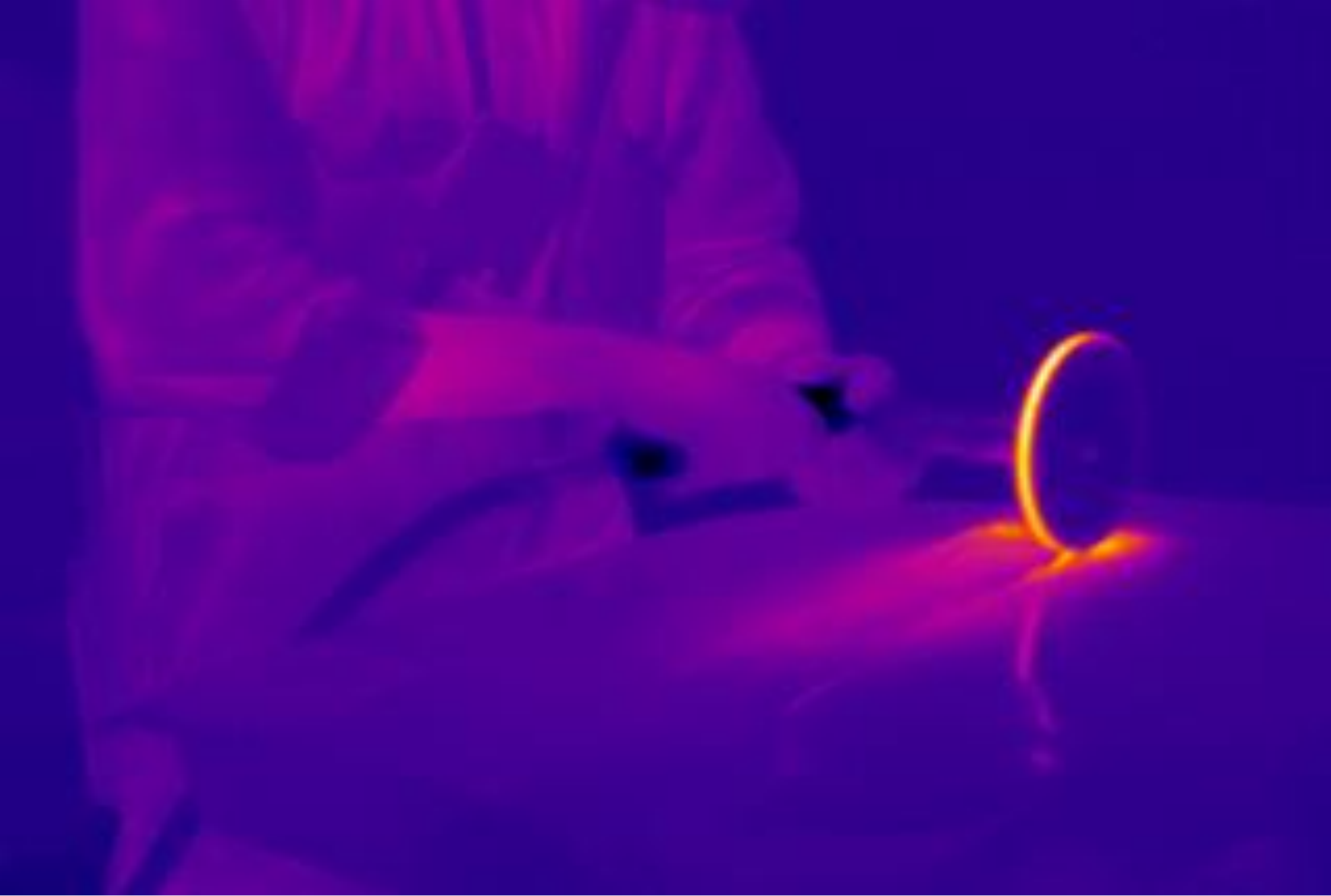



Alternatives for air sampling



- Active sampling
 - Vapour and particles
- Passive sampling
 - e.g. Diffusive sampling
 - vapours only

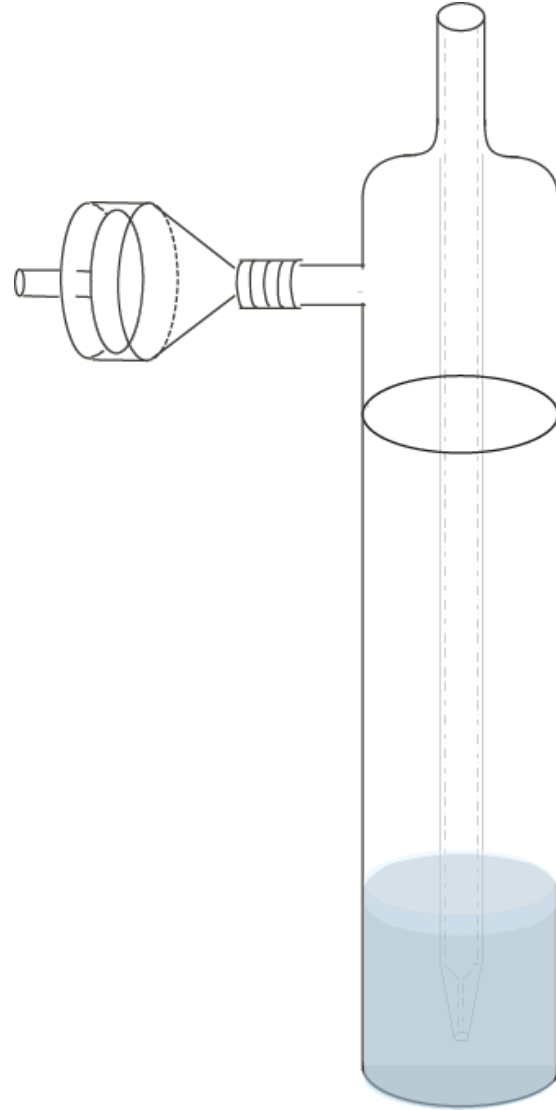
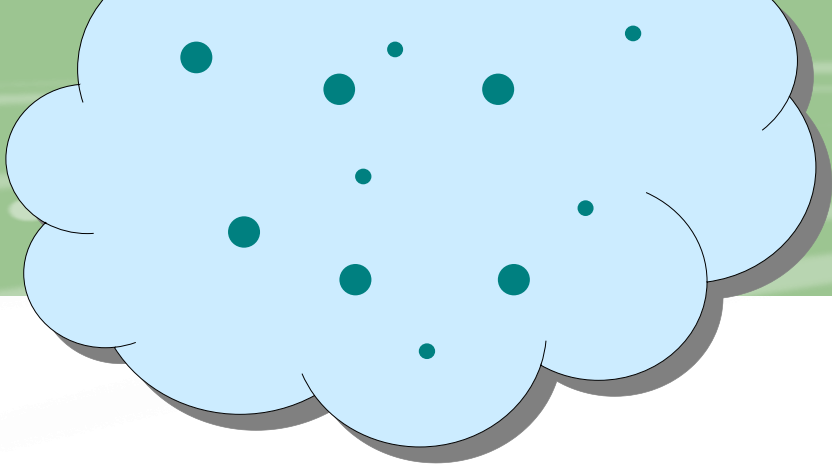

Solvent-free sampler - principle

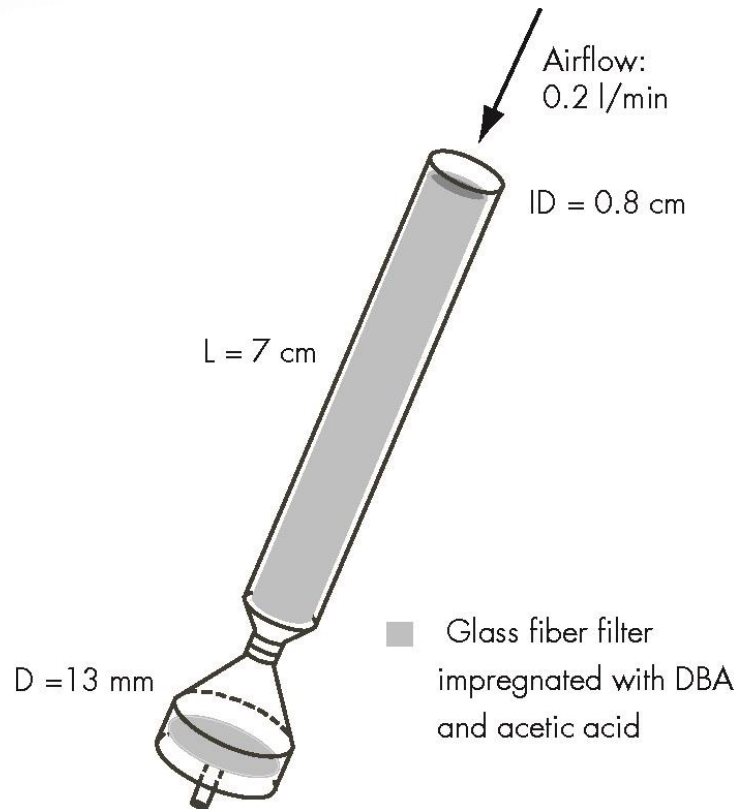

- Collection of both gas and particle phase isocyanates
- Continuous refreshing of DBA on the end-filter
- DBA amount sufficient for > 8 h sampling
- Field extraction not necessary

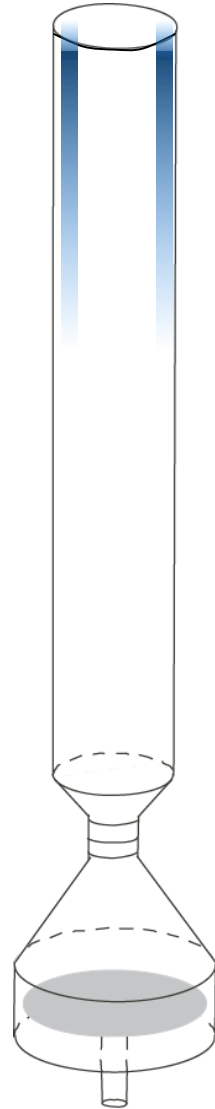
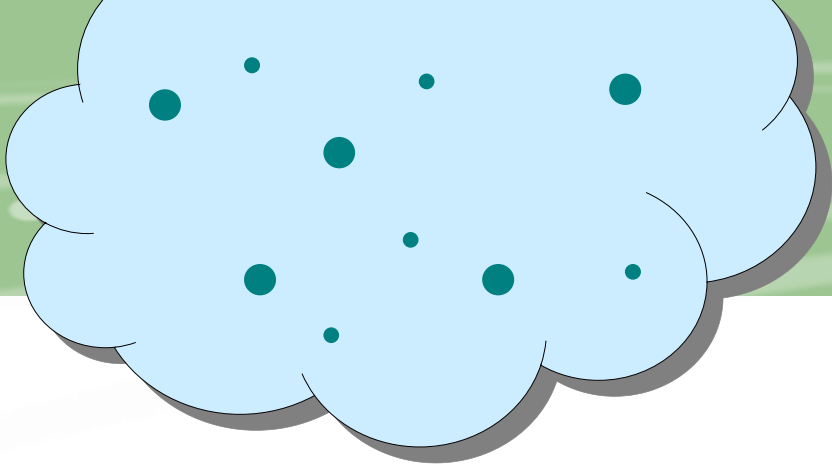



Sampling of respirable isocyanate particles

- Different parts of the denuder impactor sampler



E. High efficiency impactor (0.71-10.1 μm aerodynamic diameter) and a 40 mm diameter V-shaped filter, collecting gaseous phase isocyanates only.

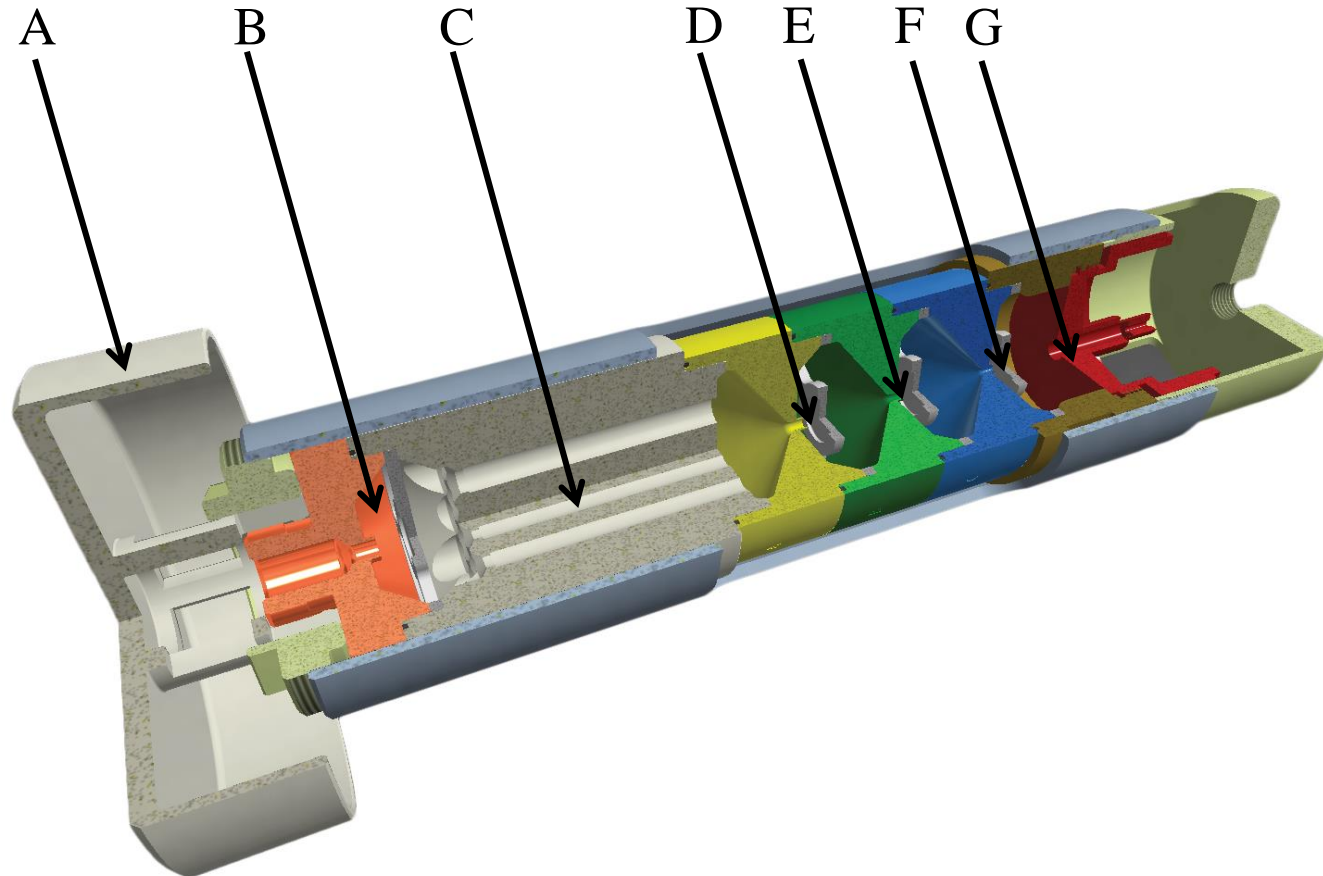

Sampling of respirable isocyanate particles

- Denuder impactor (DI) sampler - Operation principle

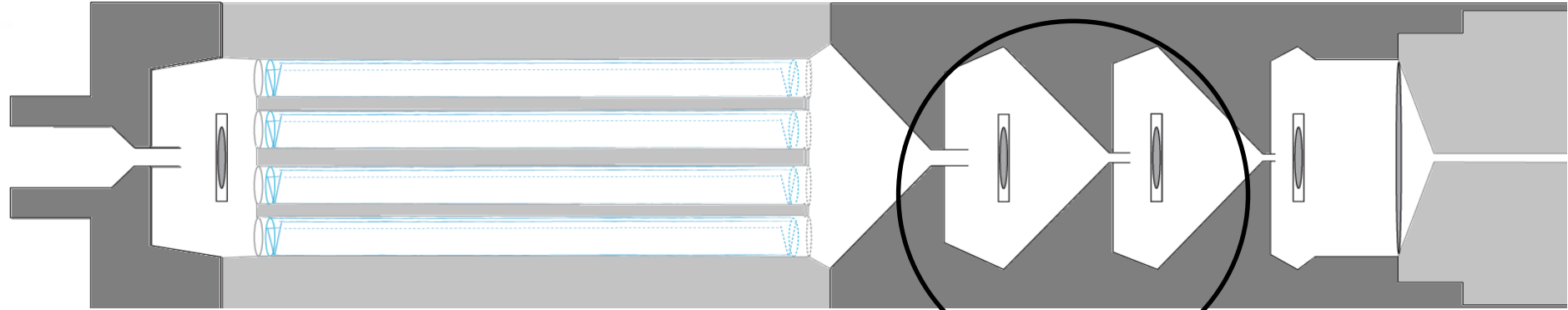

Pre-impactor stage

- Collects particles $d_{50} > 10 \mu\text{m}$ (PM 10)

Denuder

- Collects gas

Impactor stages

- Collects particles in different size fractions:
 d_{50} for 4, 2.5 (PM 2.5) and $1 \mu\text{m}$ (PM 1)

End filter

- Collects particles $< 1 \mu\text{m}$

Respirable particle fraction

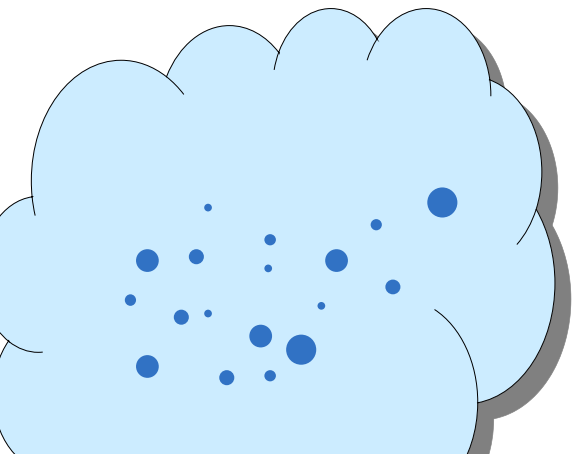

Impactor sampling

- Determination of particle size distribution of isocyanates generated from thermal degradation of car coating

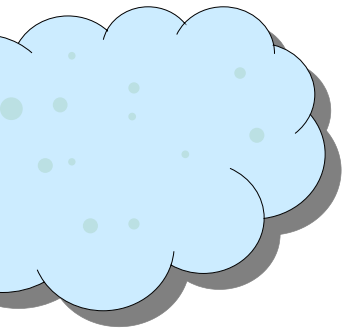
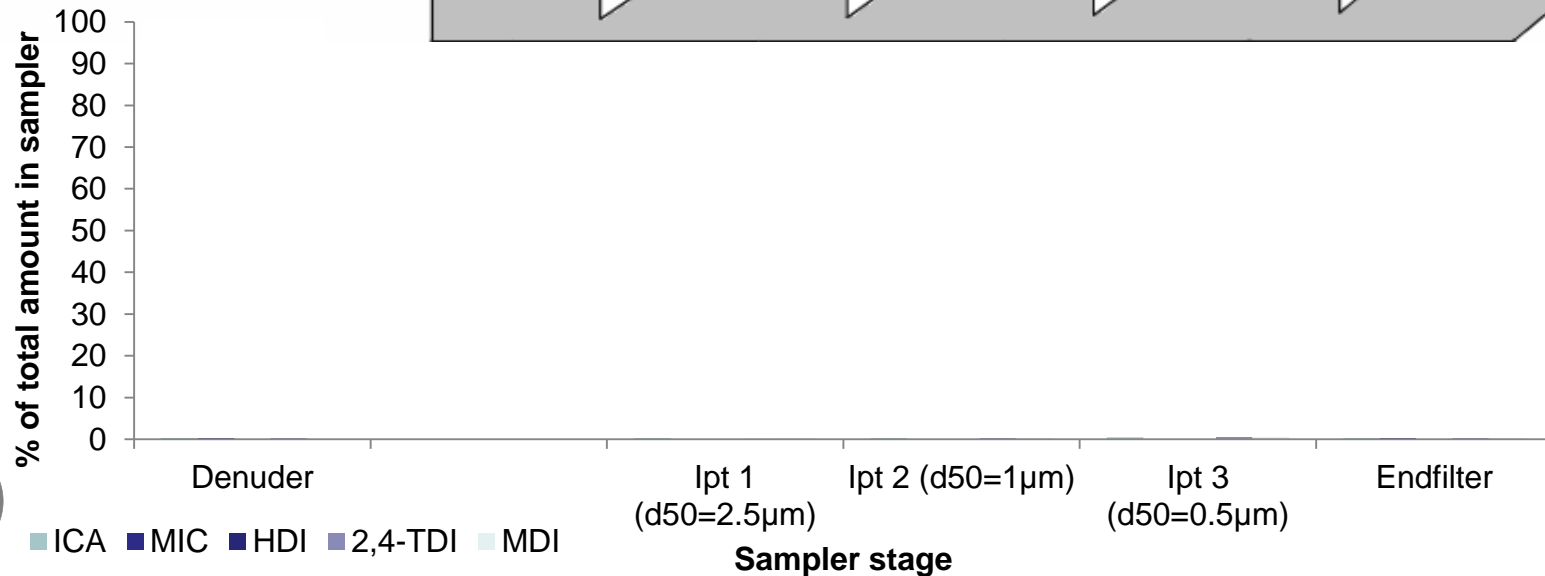
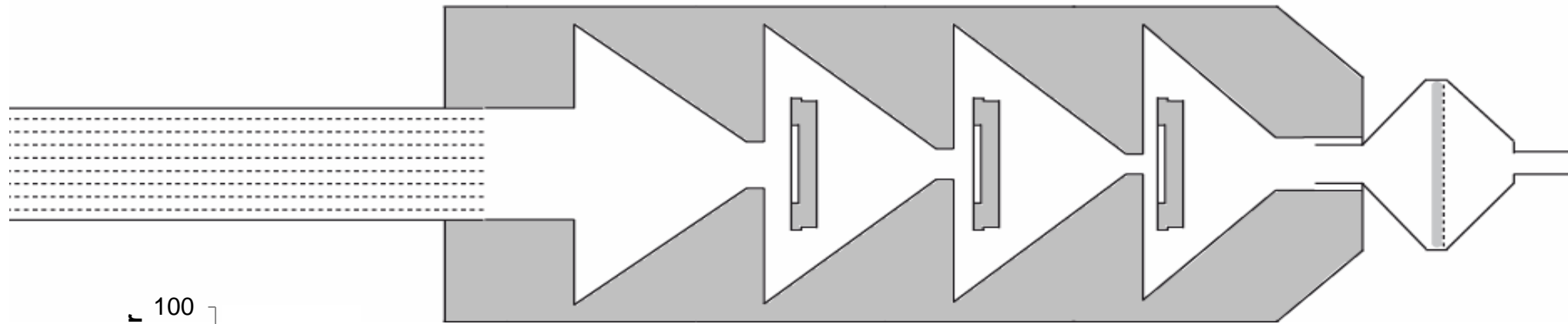

Thermal degradation of PUR-coating

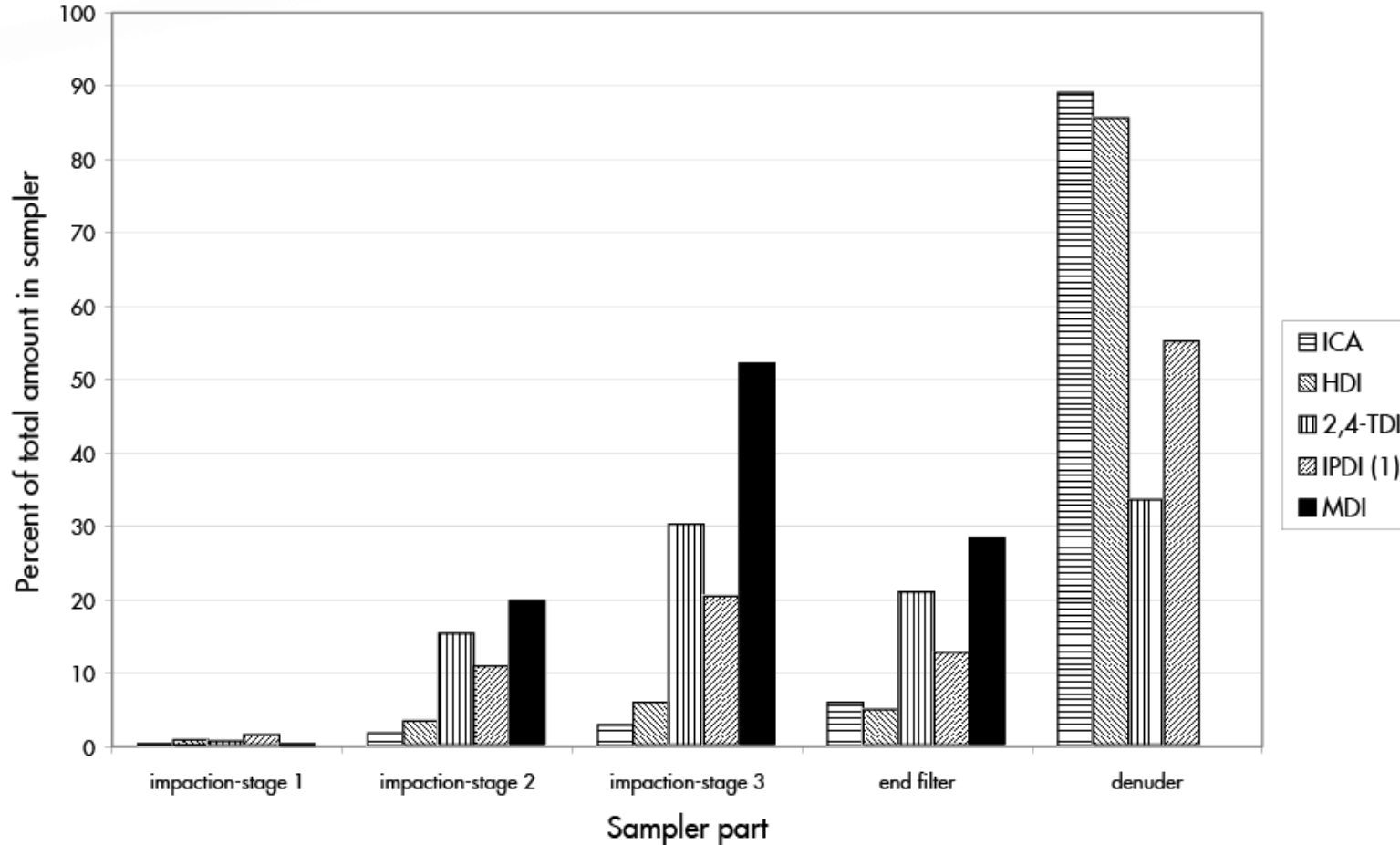

Total air levels: ICA 830 $\mu\text{g}/\text{m}^3$, HDI 96 $\mu\text{g}/\text{m}^3$, 2,4-TDI 45 $\mu\text{g}/\text{m}^3$,
IPDI (1) 70 $\mu\text{g}/\text{m}^3$, MDI 20 $\mu\text{g}/\text{m}^3$



Impactor sampling

- Determination of particle size distribution of iron, Fe

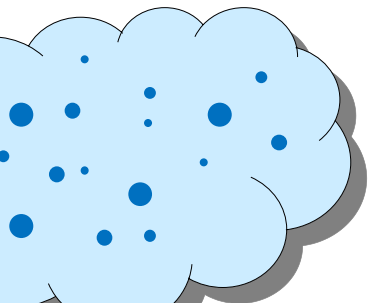
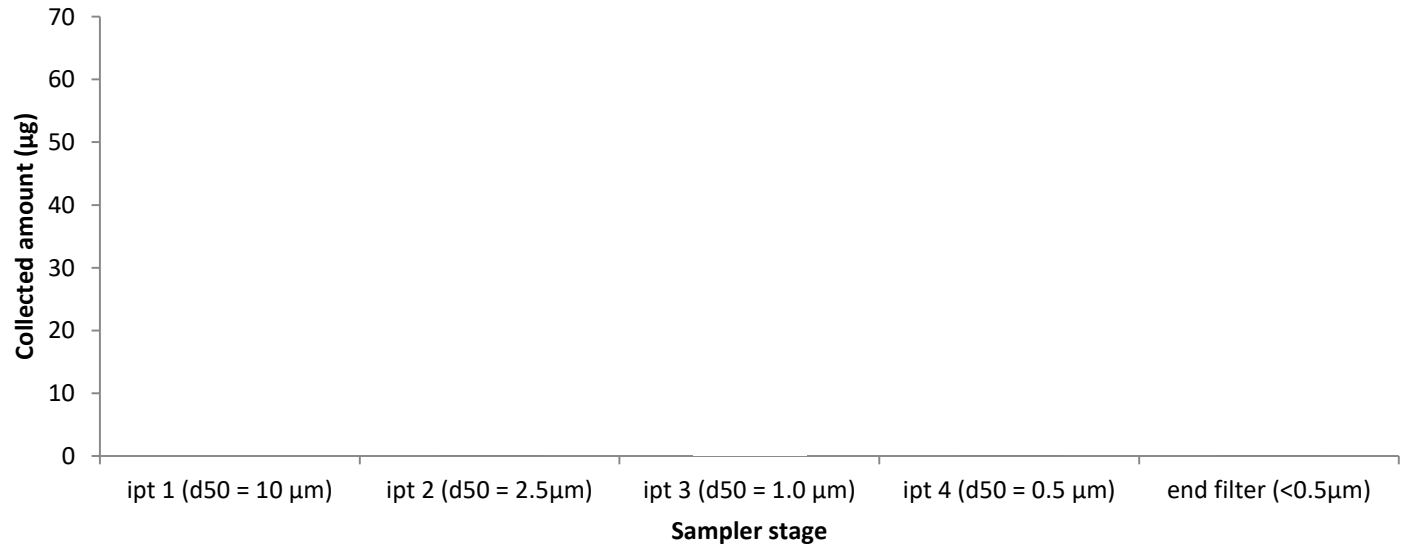
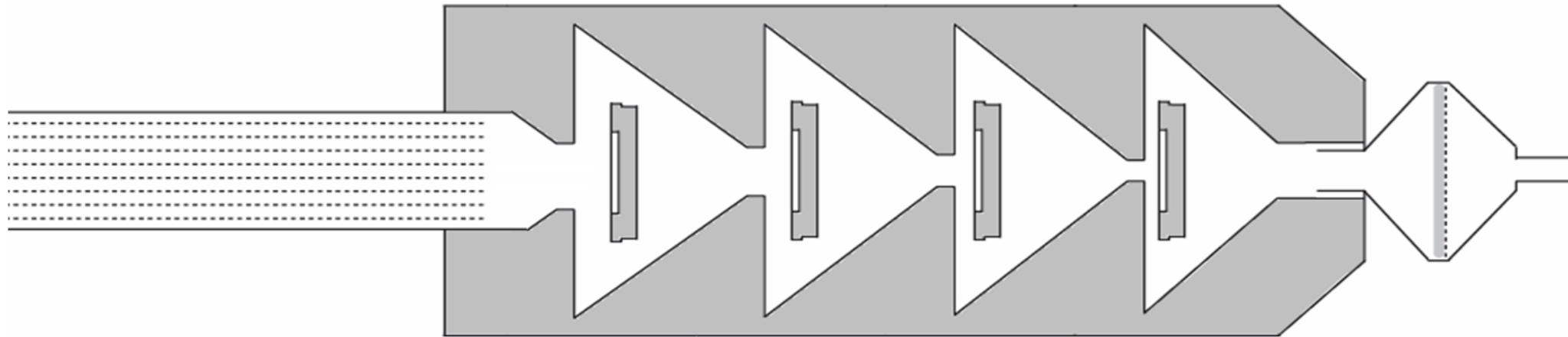

Impactor sampling

- Determination of particle size distribution of mercury, Hg

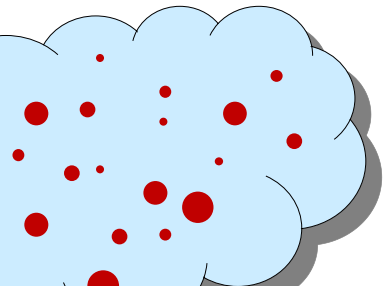
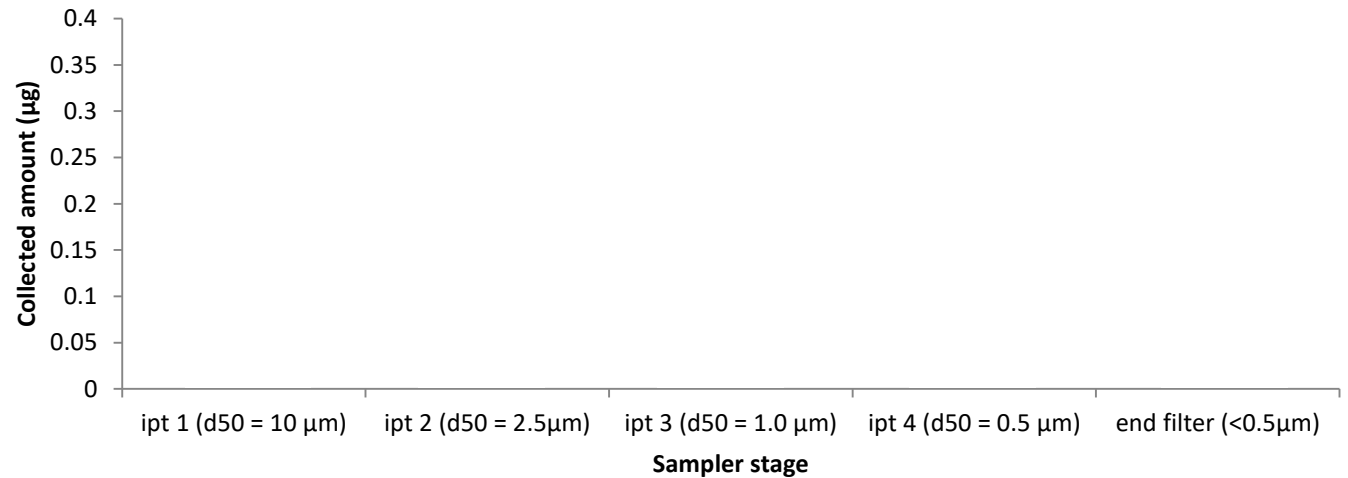
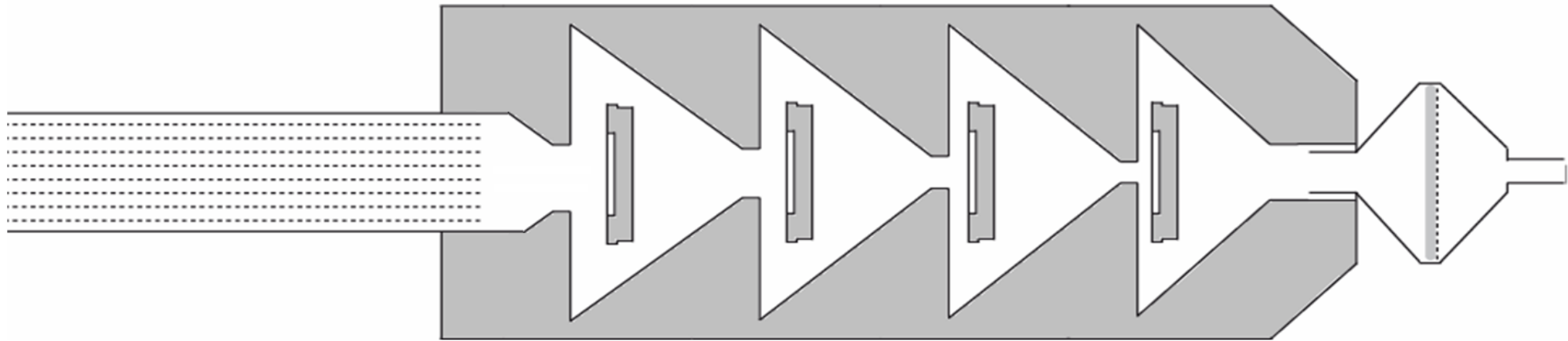

Impactor sampling

- Determination of particle size distribution of arsenic, As

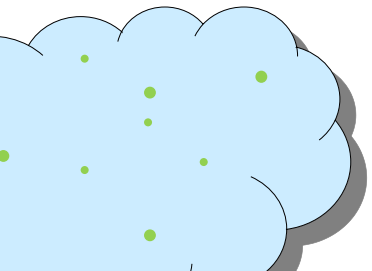
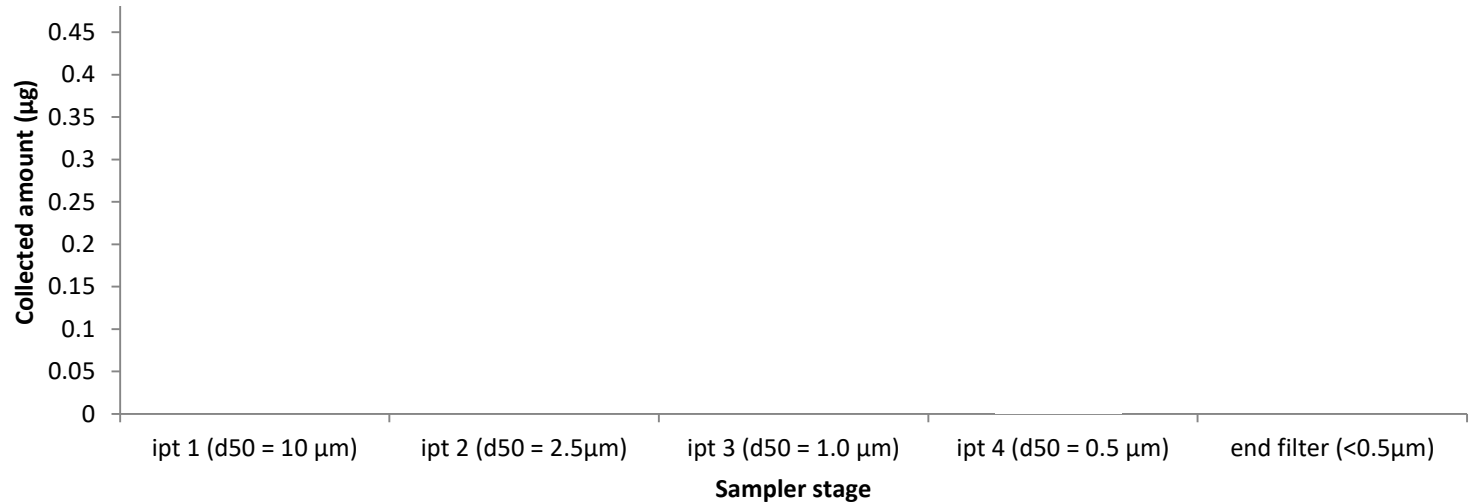
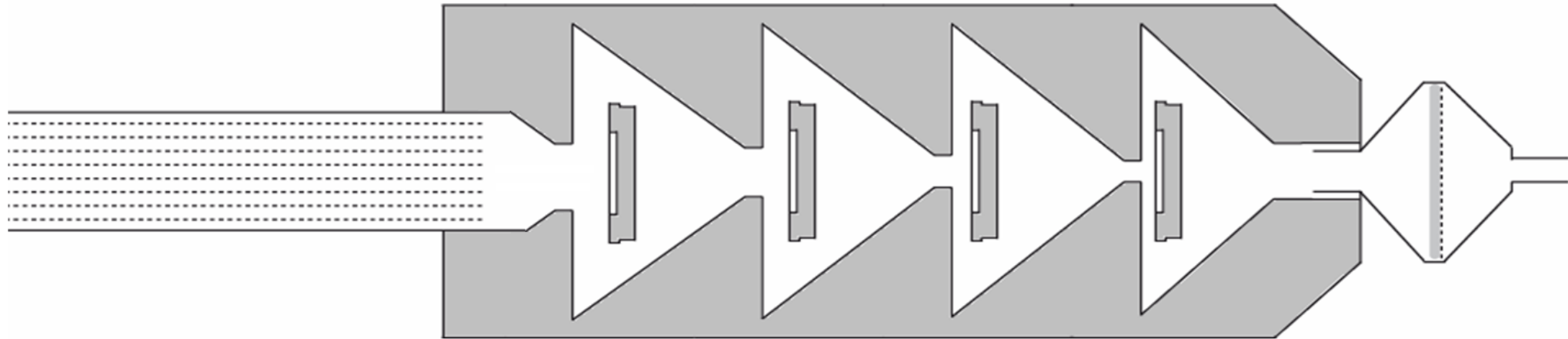

Impactor sampling

- Determination of particle size distribution of chromium, Cr

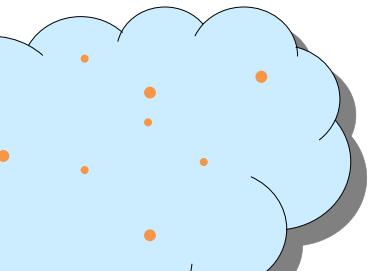
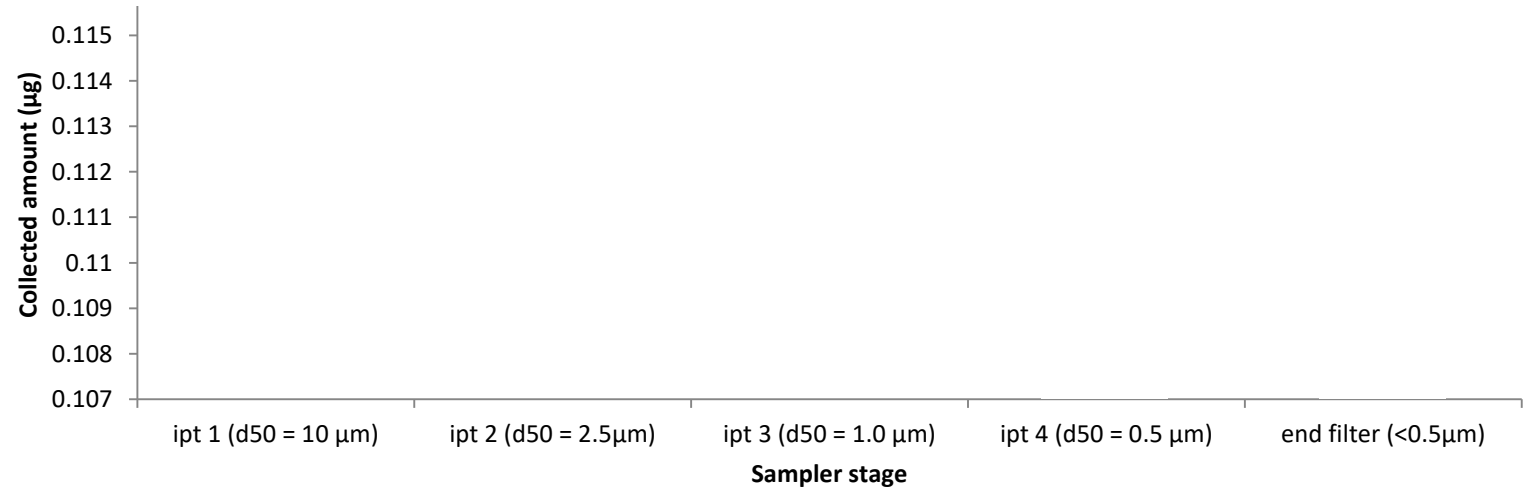
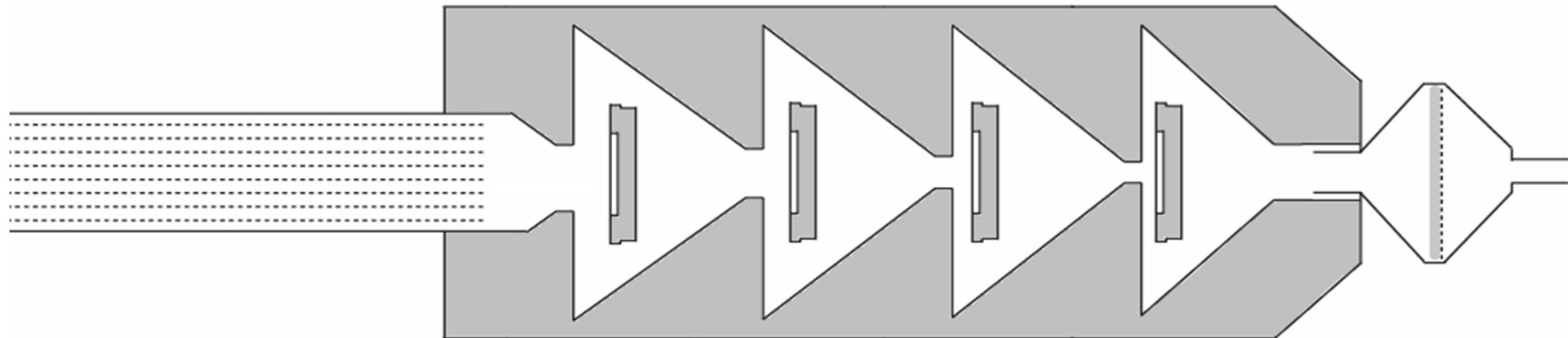



Results - Sundström SR 515 and SR 510

- Exposure to HDI and IPDI ($\sim 25\text{-}180 \mu\text{g}/\text{m}^3$) at 60 and 80 % RH and 20 °C
- NO Administrative norms: HDI 35 $\mu\text{g}/\text{m}^3$, IPDI 45 $\mu\text{g}/\text{m}^3$

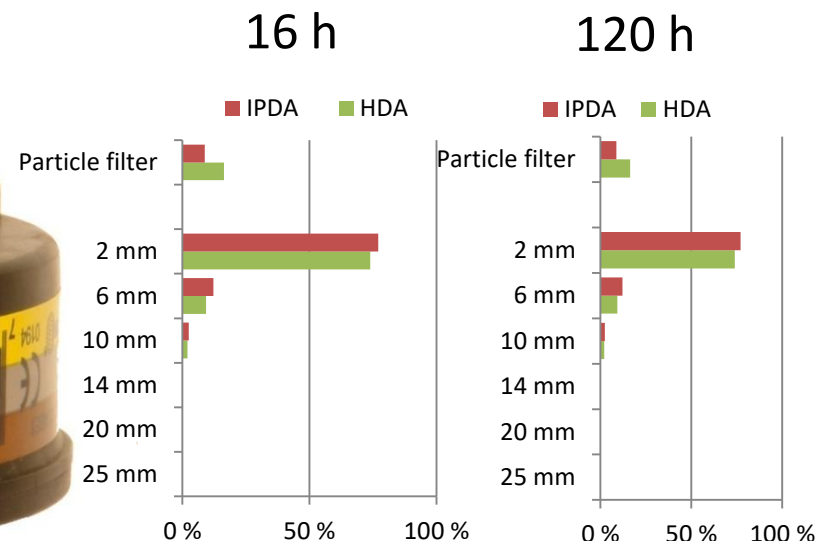

IFKAN Air sampling pump

Accuracy & Reliability



- True mass-flow meter for measuring flow accurately over entire flow range
- Additional sensors for ensuring correct measurement
- PID-controller for maintaining stable flow
- (Factory-calibrated, does not need field calibration)
- Unique pump technology for pulsation-free flow and vibration-free operation
- **Provides reliable sampling of air into sampler – reduces the error contribution from sampling when evaluating sampler!**

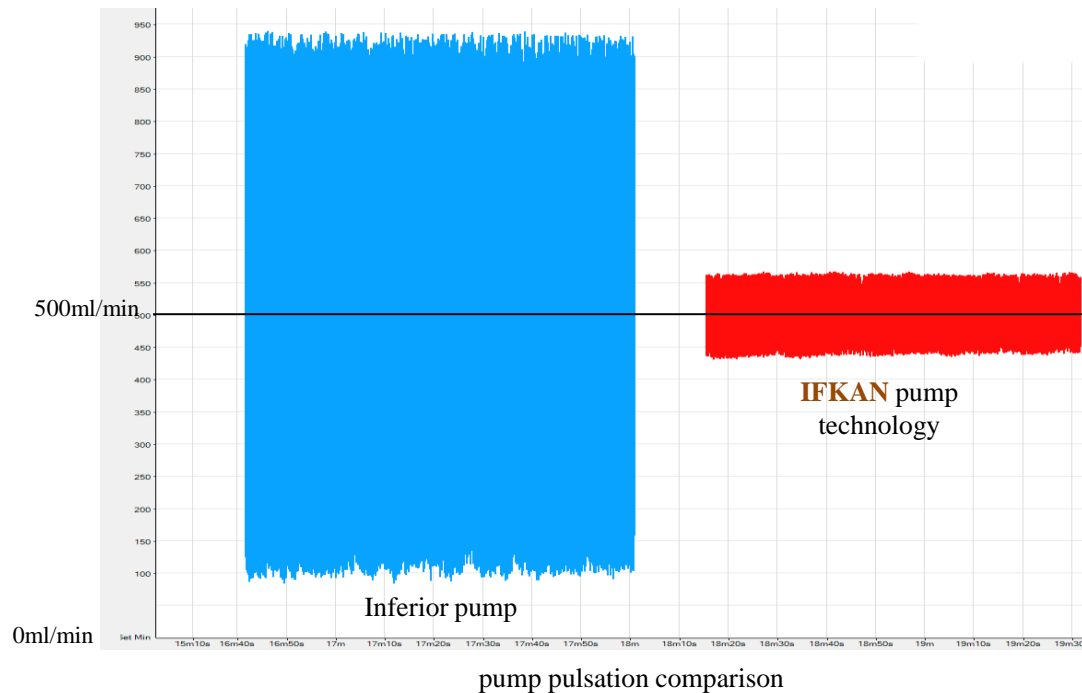

IFKAN Sampling Studio

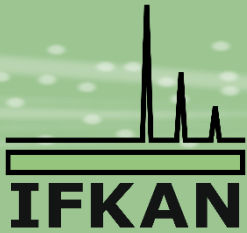

- Can connect to multitude of instruments
 - Pumps
 - Flow meters
 - Pressure/temperature/humidity sensors
 - Heat controllers
 - Dose pumps
 - Direct reading instruments
 - Climate chamber sensors and control units
 - Etc...
- Implements a multitude of communication protocols
 - RS232
 - OPC
 - Modbus
 - USB (HID or serial)
 - TCP/IP
- Monitors and plots incoming data into a graph and logs to file
- Advanced graph functions for evaluating and manipulating data
 - Mathematical operations between different graphs
 - Statistics tool for evaluating average / standard deviation, integrals, noise levels.
 - Advanced filtering functions
- Controllable parameters can be controlled manually or according to a schedule for automatic sequences
- Relationships between different instruments can be setup for PID controlling a property (e.g.) controlling a compressor by measuring from a pressure sensor.

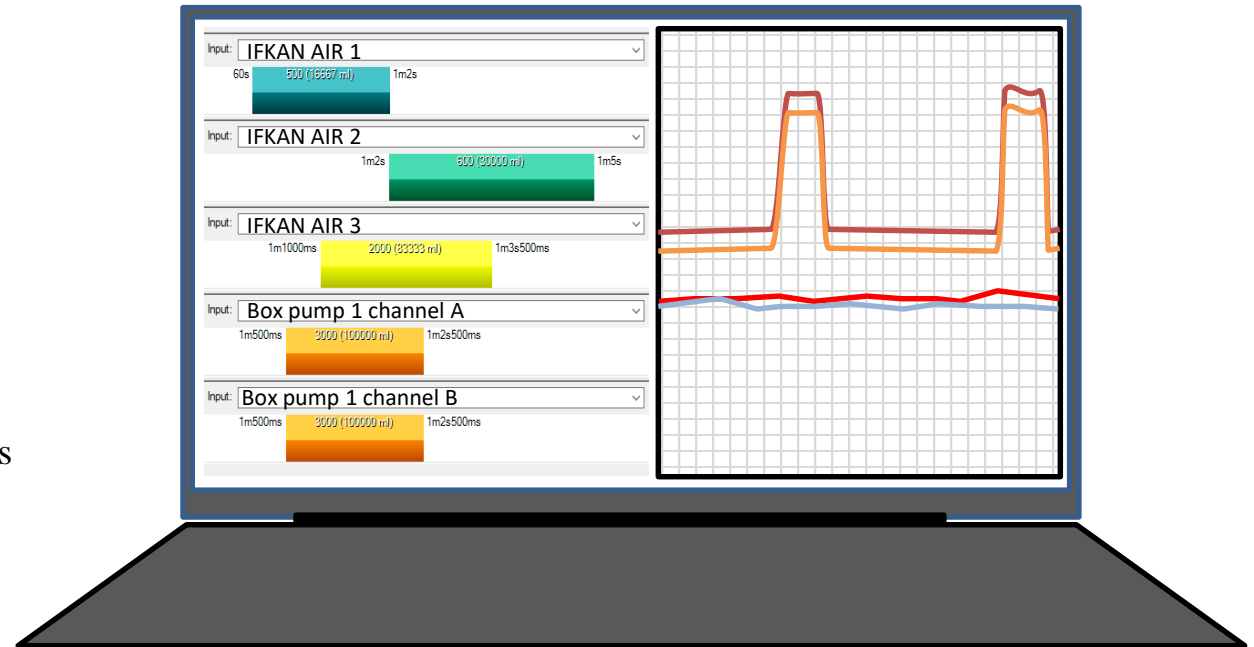

Advanced control features

Example: smoking scenario



- The IFKAN single pump has been used to simulate cigarette smoking scenario with a controlled, repeatable setup, simulating a typical inhalation profile for smoking a cigarette:
 - Smoking puff volume: 55ml
 - Duration: 2s
 - Repeated with x seconds interval.
- Flow schedule can be setup with following periodic sequence:
 - Wait 1s
 - Ramp for 500ms
 - Maintain stable flow for 1250ms
 - Ramp down for 250ms
 - Idle 20 seconds
 - Repeat.
- Configuring schedule and monitoring result can be done in IFKAN Sampling Studio

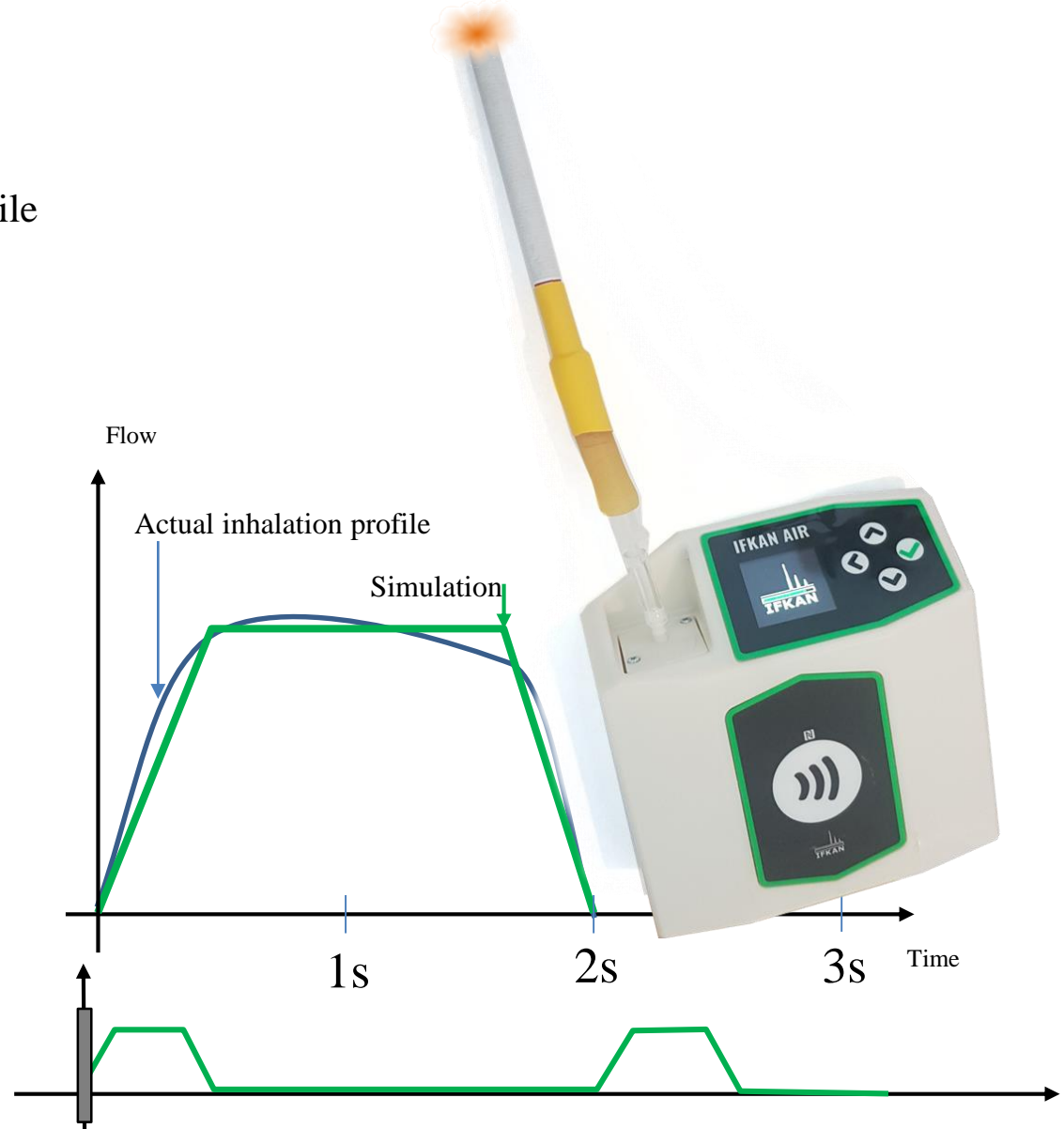

Sampling of respirable isocyanate particles

- Generation system for particle borne MDI



1. MDI vaporisation chamber for heating of technical MDI in a nitrogen flow.
 - Technical MDI is vapourized in a heater and nitrogen gas is used to carry the MDI-vapour. An additional heated nitrogen flow is used to dilute the MDI vapour.

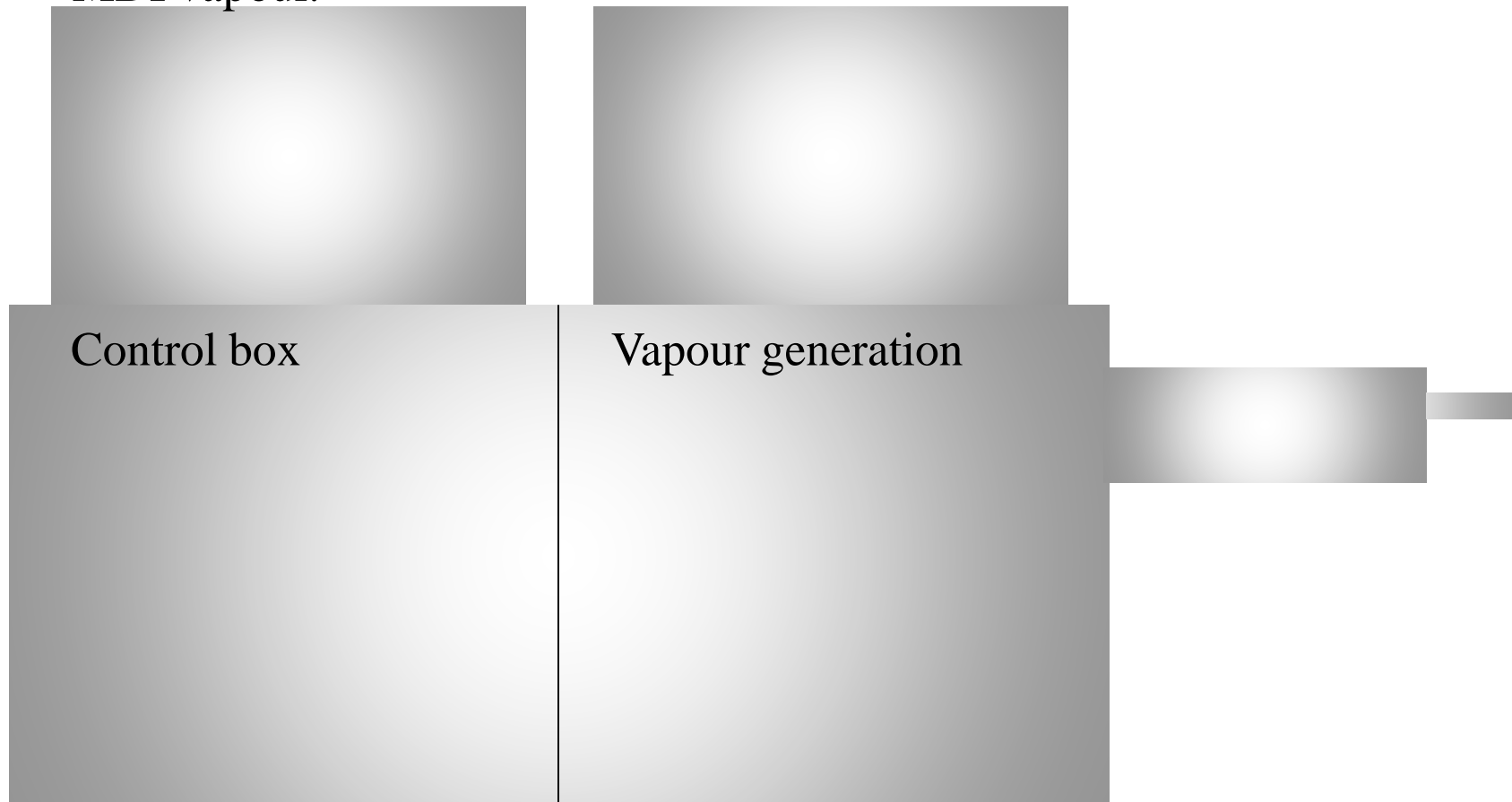

Sampling of respirable isocyanate particles

- Generation system for particle borne MDI



2. Nucleation particle generation chamber for generation and drying of NaCl-particles.
 - NaCl-particles are generated by using a nebulizer, NaCl-water solution and pressurized air to create a spray.
 - The generated NaCl-aerosol is diluted and dried inside the chamber by a continuous flow of dry pressurized air (no recirculating flow).



Sampling of respirable isocyanate particles

- Generation system for particle borne MDI



3. Mixing chamber for gaseous MDI and NaCl-particles => MDI-particles

- When the heated MDI-vapour meets the NaCl-particles inside the mixing chamber, the MDI-gas will begin to condense on the NaCl-particles.
- This makes the particles grow, causing a shift in the size distribution towards larger sizes.

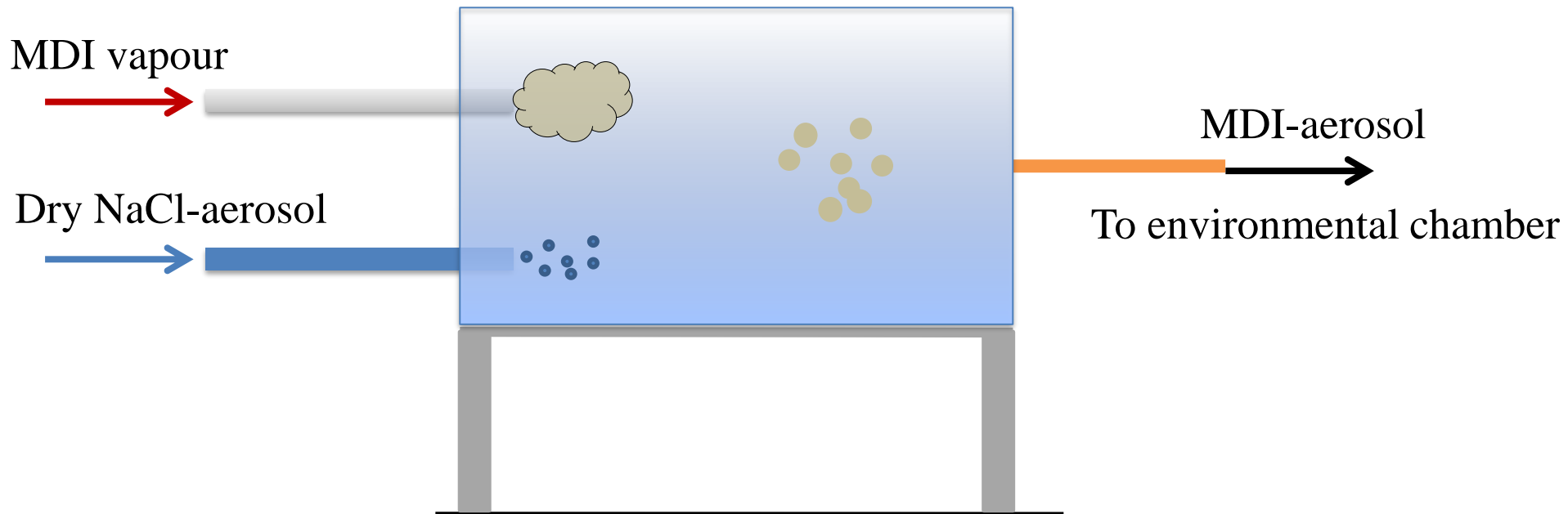

Sampling of respirable isocyanate particles

- Experimental – MDI particle size distribution in a NaCl nucleus aerosol



- NaCl nuclei was mixed with gaseous MDI to create a controlled MDI-aerosol by heterogenous nucleation
- The SMPS-system was used to determine the difference between the particle size distribution of the NaCl-aerosol alone and the NaCl-aerosol combined with gaseous MDI (after heterogenous nucleation).
- To investigate the composition of the NaCl-MDI aerosol, the Classifier and Differential Mobility Analyzer (DMA) from the SMPS-system was used to separate different size fractions of the MDI-aerosol and Asset-samplers were used to sample these fractions. The denuder part and the end filter of the Asset-sampler were analyzed separately.

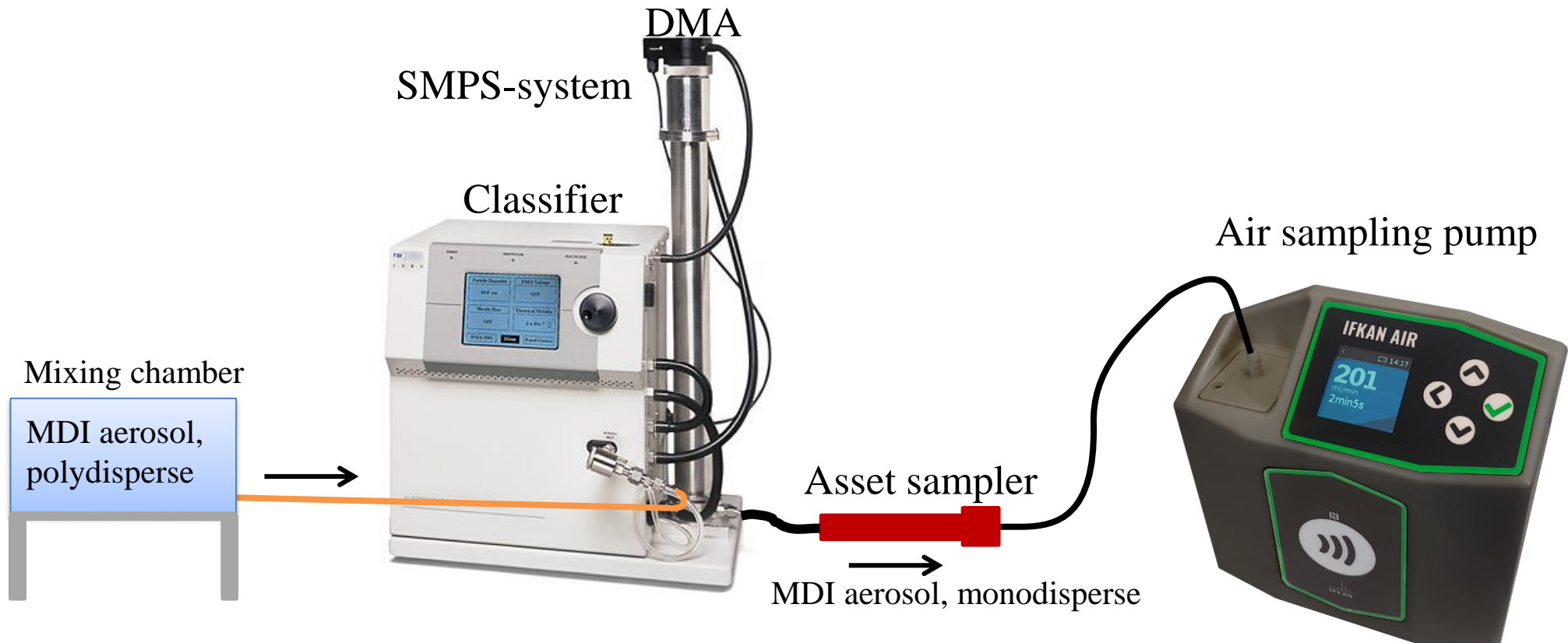

Sampling of respirable isocyanate particles

- Experimental – MDI particle size distribution in a NaCl nucleus aerosol

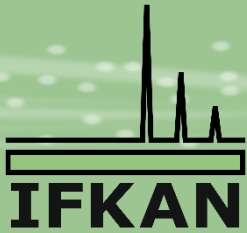

- Differential Mobility Analysis is based on the principle that the ability to traverse an electric field related to particle size.
- In the Differential Mobility Analyzer an electrical field is created and the airborne particles drift in the DMA according to their electrical mobility.
- Only a particular particle size fraction is allowed to pass through the DMA, the rest of the particles adhere to the high voltage rod in the middle of the DMA or is lead out with the excess air.
- A particle counting instrument (condensation particle counter) can be used to determine the particle number concentration of a certain particle size fraction.

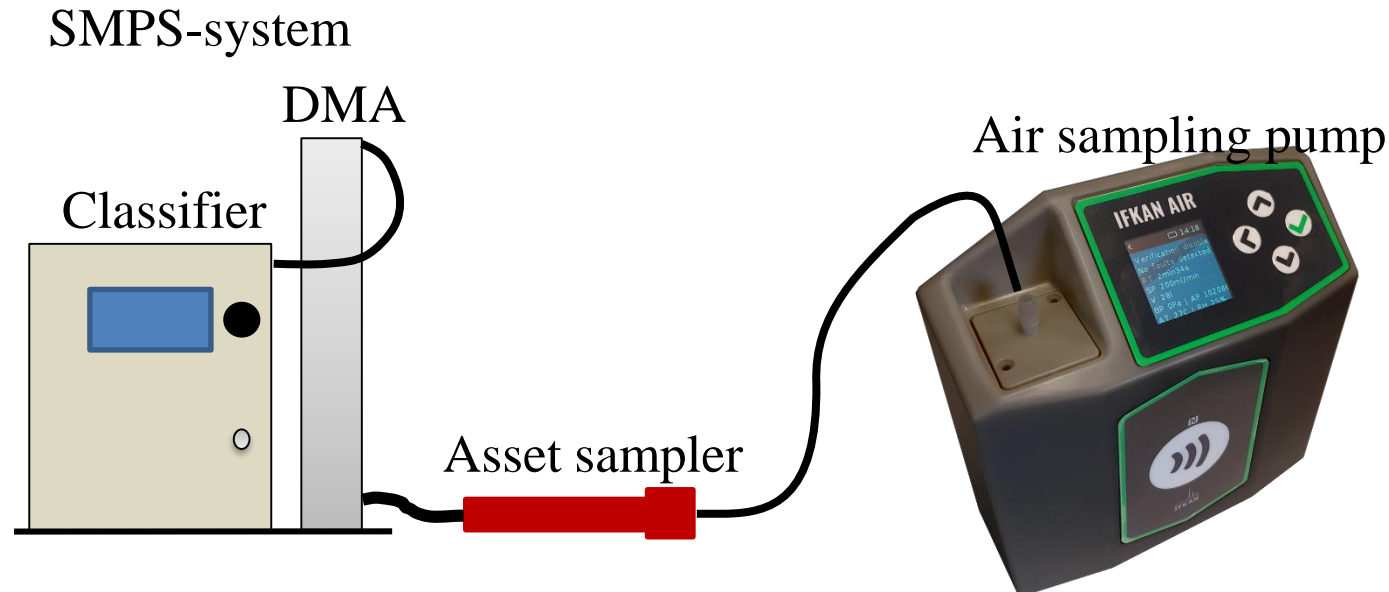

Sampling of respirable isocyanate particles

- Experimental – MDI particle size distribution in a NaCl nucleus aerosol



- SMPS system – principle of operation

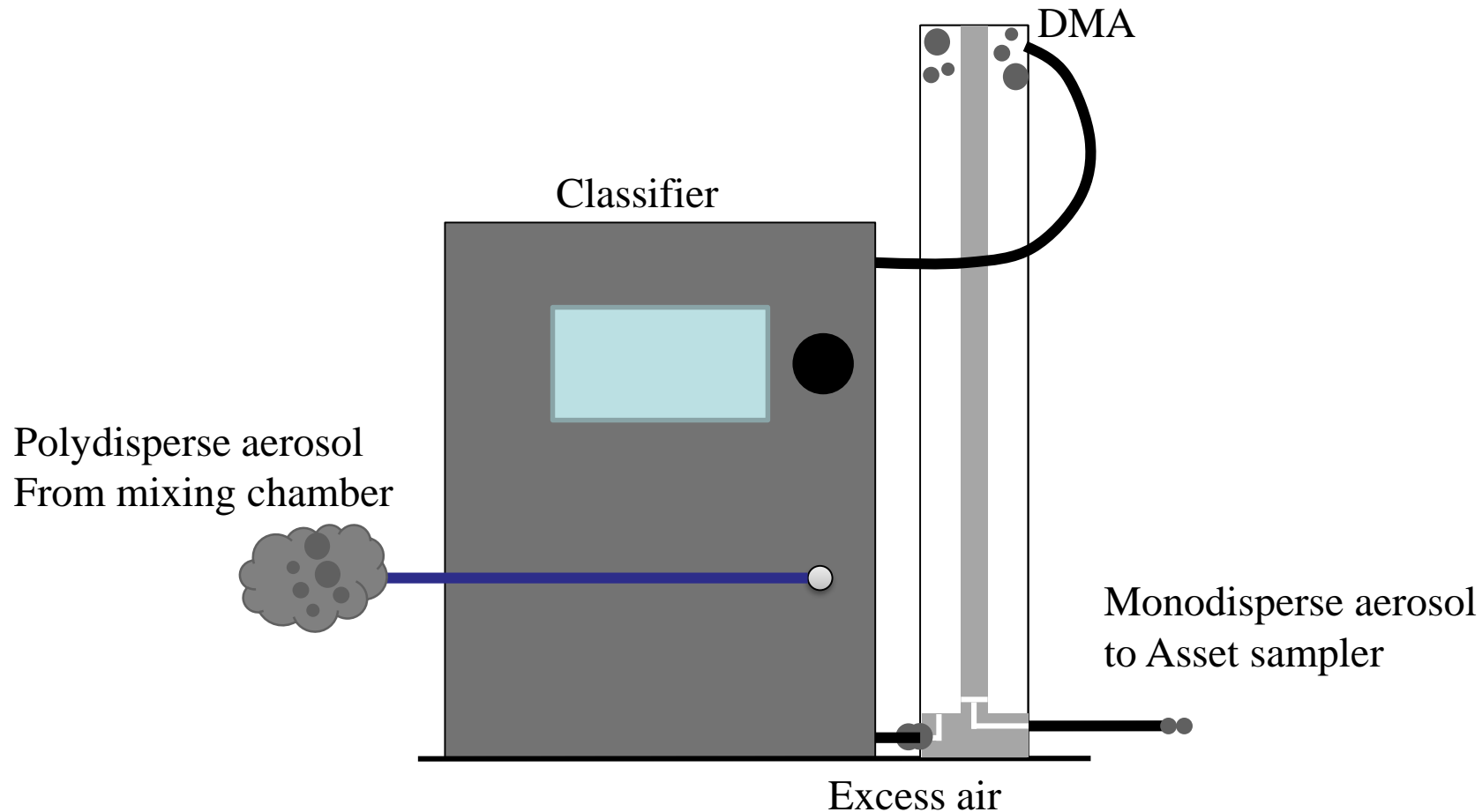

Sampling of respirable isocyanate particles

- Experimental – MDI particle size distribution in a NaCl nucleus aerosol

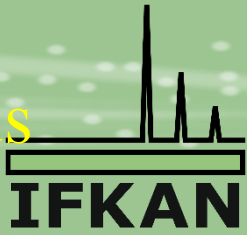

- Separation of gas and particles in the different parts of the Asset sampler

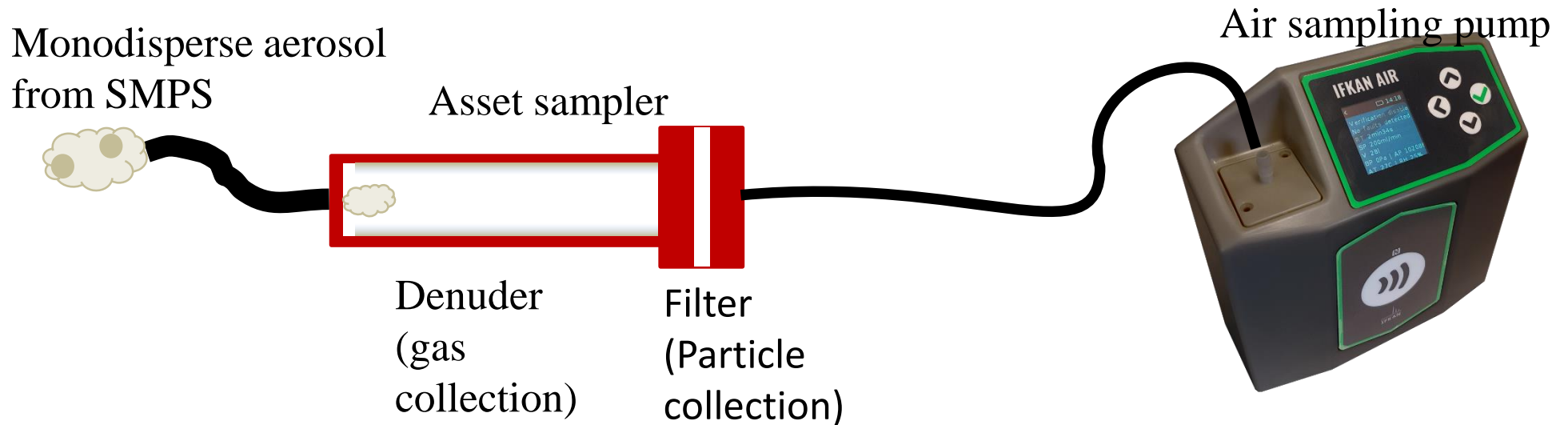

Isocyanate gas and particle generation

- Results- Generation system for particle borne MDI



Measured with Scanning Mobility Particle Sizer (SMPS) with Condensation Particle Counter (CPC) and SMPS-dry sampler, RH was < 20%.

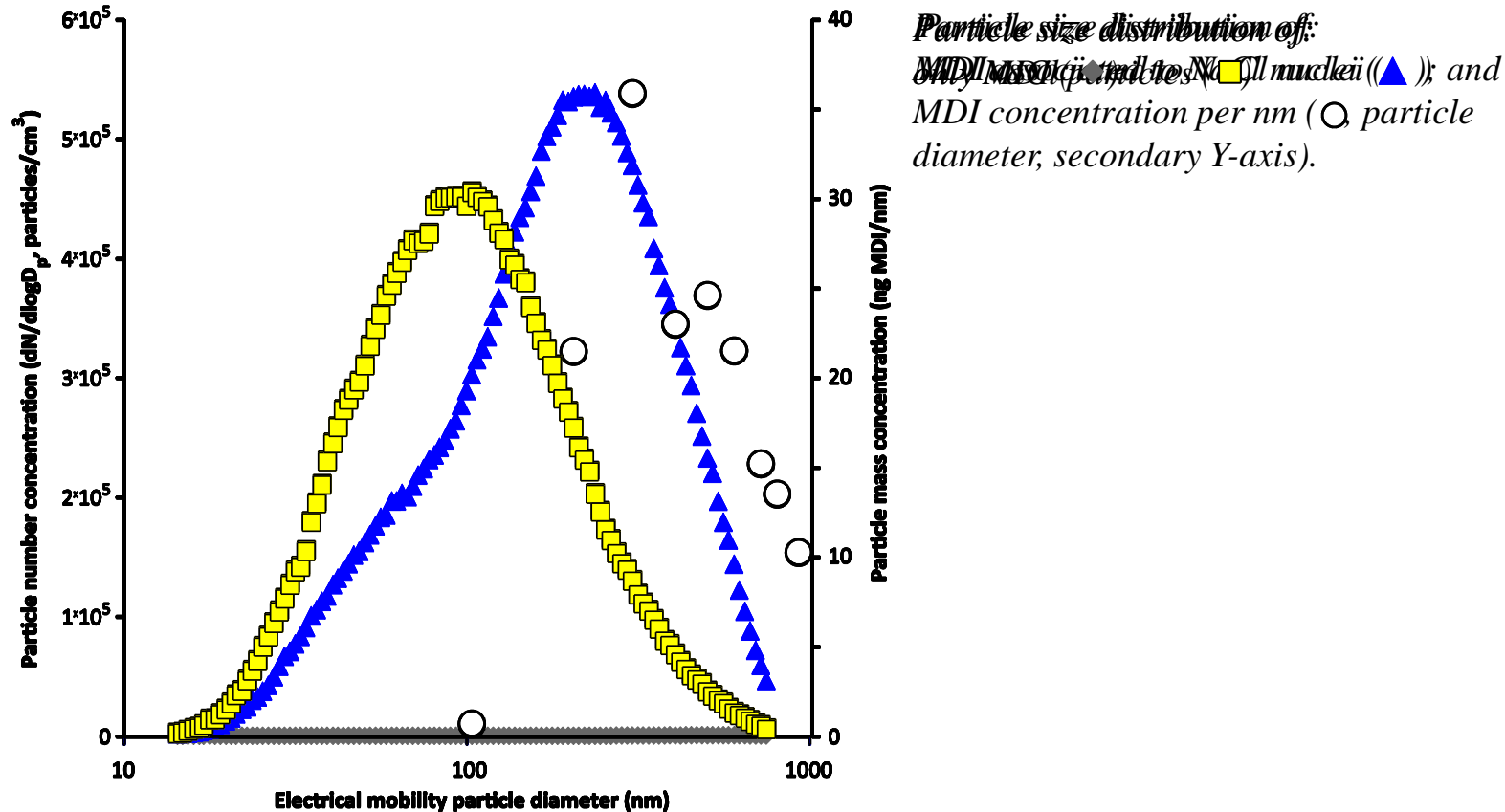

Sampler prototype – virtual impactor

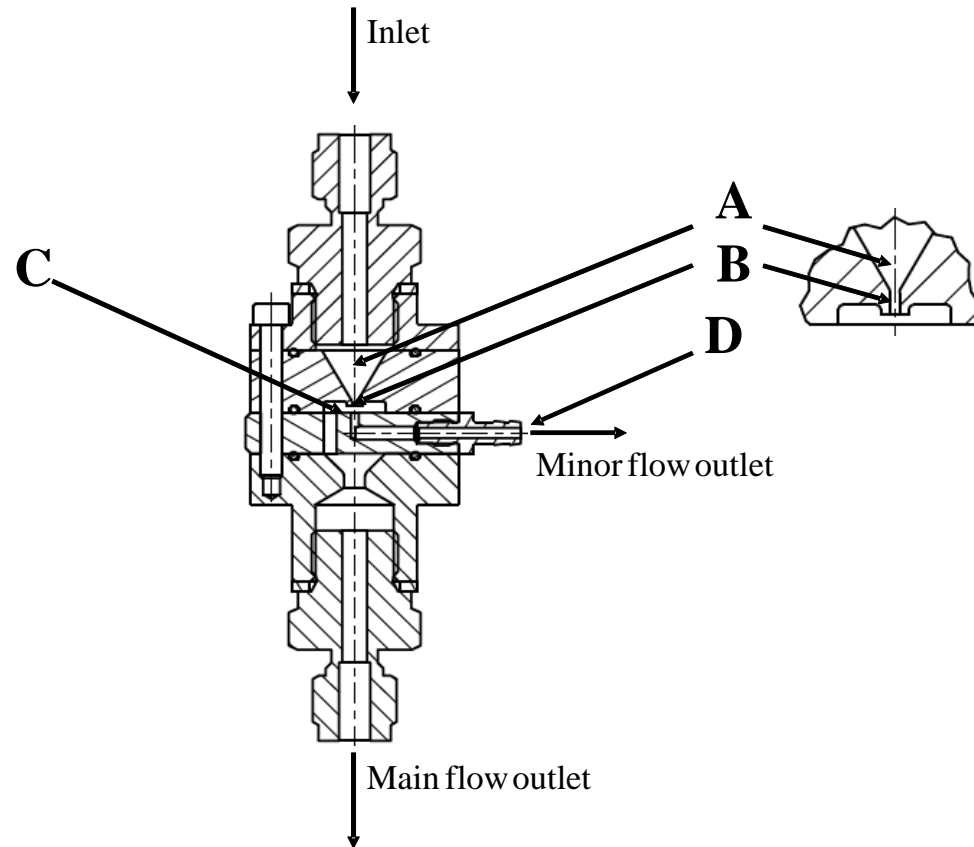

The inlet flow passes through a cone (A) with a small nozzle (B) to speed up the linear flow. The flow stream is directed to an impactor plate (C) to trap the particles. The impactor plate is connected with a tube (D) having a small flow, 1/10 of the main flow, to separate the particles larger than the cut off size from the main flow stream.

Sampler prototypes

1

Gas and respirable particles sampler

Gas and particles $<4\mu\text{m}$ are determined separately.



2

Total sampler

Gas and particles are determined separately.



3

Total sampler

Sum of gas and all particles.



Multichannel denuder in an ATD-tube

For highest collection efficiency of gas phase – maximize the number of channels with a minimal increase in linear flow velocity

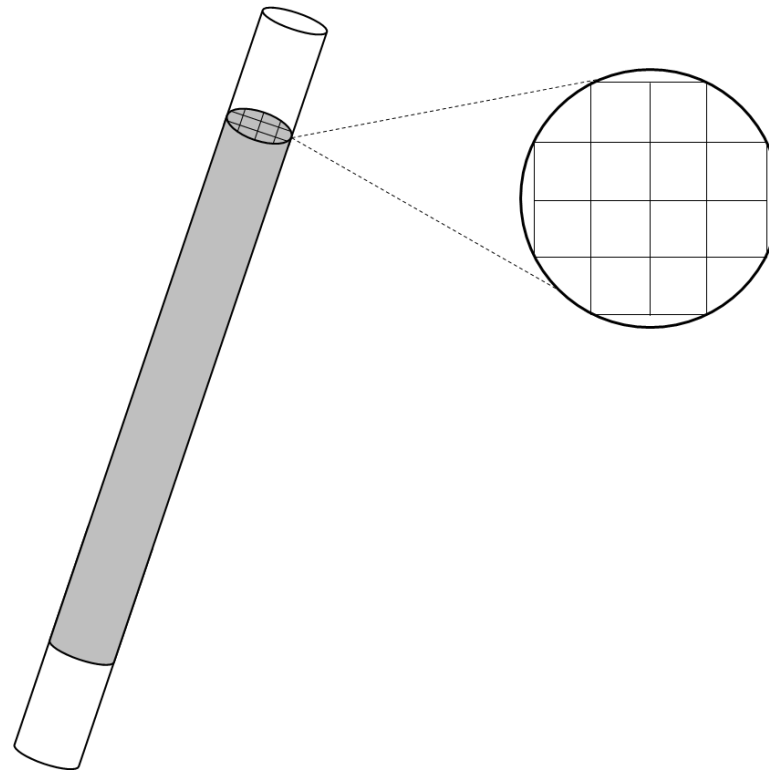

**NEW
ISOCYANATE
RISKS
DISCOVERED**

**EUROPEAN MINE, CHEMICAL AND ENERGY WORKERS FEDERATION (EMCEF)
EUROPEAN FEDERATION OF BUILDING AND WOOD WORKERS (EFBWW)
EUROPEAN TRADE UNION FEDERATION: TEXTILE, CLOTHING AND LEATHER
(ETUF TCL)**

**NORDIC INDUSTRY WORKERS' FEDERATION (NIF)
NORDIC FEDERATION OF BUILDING AND WOOD WORKERS (NBTF)
NORDIC METAL**

**European Trade Unions
Call for Action to Protect
Workers from
Harmful Isocyanates**

HANDLING THE HEAT



Polyurethanes & Thermal Degradation

api ALLIANCE FOR THE
POLYURETHANES
INDUSTRY
A BUSINESS UNIT OF THE
AMERICAN PLASTICS COUNCIL

1300 Wilson Blvd., Arlington, VA 22209
(703) 741-5656 • FAX (703) 741-5655
www.polyurethane.org • email: API@plastics.org

2006

Definition of Thermal Degradation

The chemical breakdown of materials when heat is applied.

Examples of Hot Work

Hot work performed on or near polyurethanes, such as paints, lacquers or insulation, may be done through a variety of different processes. Some examples of these methods are listed below.

- Welding
- Heating of polyurethane foam while working on pipes
- Heating MDI-based glues
- Soldering
- Treatment with a heat gun
- Cutting with torches or hot wire
- Hot scissors
- Grinding
- Sawing

The Risks

It has been estimated that non-flaming thermal degradation of some polyurethane products may begin as low as about 150°C (300°F). However, it is important to note that the temperature at which thermal degradation starts can vary due to the many different heating processes and with the various types of polyurethanes used. When polyurethanes undergo thermal degradation some toxic chemicals may be emitted. This may or may not be seen as smoke or vapors.

The importance of being aware of this type of degradation, in part, is because of the lack of visible warning signs of the chemicals that may be released during these processes. For the most part, non-flaming decomposition occurs during industrial work processes that may lead to worker exposure issues. Use of some control measures (e.g., local exhaust ventilation and proper personal protective equipment) may reduce the risk of exposure to smoke or vapors from the thermal degradation of polyurethanes. Additional information regarding ventilation and personal protective equipment is available through the Alliance for the Polyurethanes Industry's website at www.polyurethane.org or possibly through your material suppliers.

Health Effects

A range of airborne thermal degradation chemicals may be emitted during combustion of polyurethane products. These chemicals may include carbon dioxide, carbon monoxide, nitrogen oxides, hydrogen cyanide, isocyanates and amines. The composition of these chemicals, when emitted in the form of smoke or vapors, may vary. Exposure to such chemicals may cause irritation of the eyes and respiratory tract with symptoms of running nose, watering eyes, coughing, headaches, dizziness, nausea and breathlessness. Isocyanates and amines can also cause allergic reactions (sensitization) of the skin and lungs. Workers exposed to thermal degradation of polyurethanes may experience effects as the exposure occurs or days after exposure has occurred. Medical attention should be obtained if any symptoms occur.

Prevention & Precautions

To help minimize the potential risks of exposure, when performing hot work on or around polyurethanes, keep these safety precautions in mind.

- Personal protective equipment and ventilation should be in good working order and used correctly.
- Carefully read and follow safety precautions listed on the product label and Material Safety Data Sheets (MSDS).
- As applicable, comply with training and OSHA Hazardous Communication Standard requirements (29 CFR 1910.1200).
- If you experience any symptoms of exposure, stop work immediately and see a doctor to determine if your health is at risk.
- Be aware that there may be other federal, state and local regulations that apply to the operations at your worksite beyond those mentioned in this document.
- When possible, remove polyurethanes before performing hot work processes (e.g., pipe insulation should be removed and isolated when welding is carried out).
- Where applicable and safe, consider replacement of hot wire cutting with other cutting devices such as band saws, oscillating saws and high pressure water jets, from which levels of emission breakdown is usually extremely low.

Conclusion

Performing hot work, on or around polyurethanes, may be done safely if workers understand the potential risks associated with this type of job and consider appropriate safety precautions. Workers should inquire about their company's internal product stewardship program for more safety information about working with polyurethanes or visit www.polyurethane.org.